

Eastwood[®]

DO THE JOB RIGHT.[®]

MODULAR LIGHTING SYSTEM

INSTRUCTIONS

Item
#32400
#32401
#32402
#32403

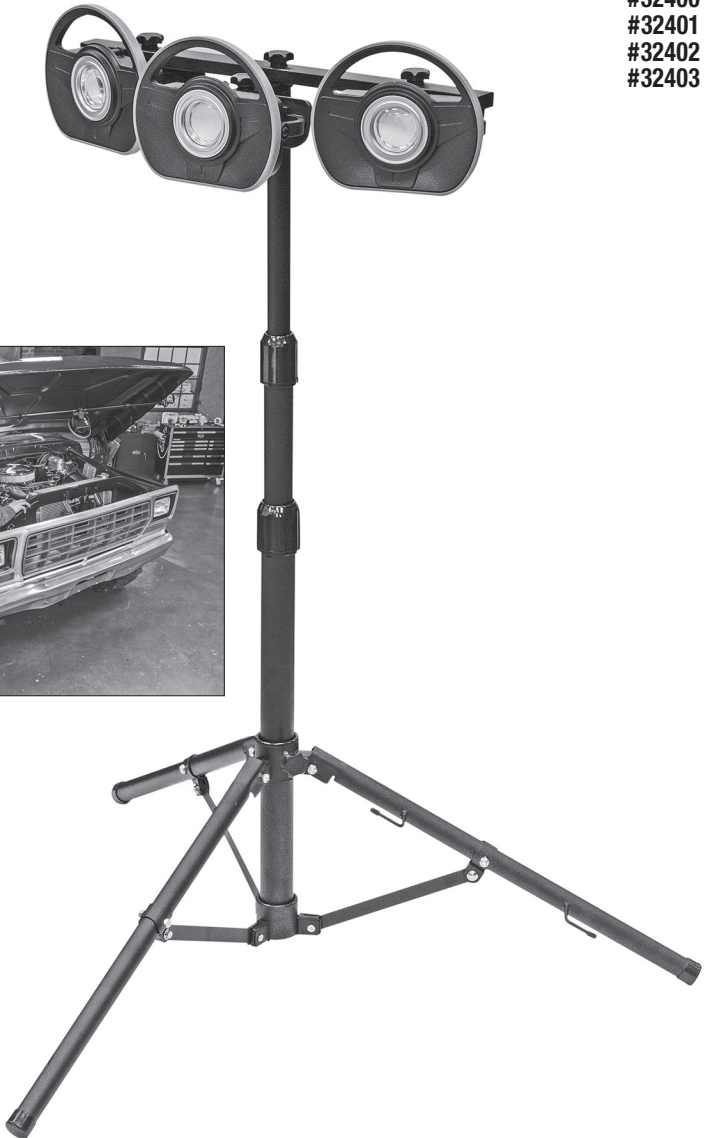

The **Eastwood Lighting System Light Module** utilizes the latest LED technology to achieve the brightest 1000 Lumen light output and most energy efficiency possible. The progressive dimming feature allows infinitely adjustable light output to provide only the light needed while conserving battery power. A solid cast aluminum housing with shock resistant protection provides tactical level reliability. The quick attaching mount design allows for use with optionally available Tripod and Underhood mounting systems.

FEATURES

- Three function Switch:
 - Press once and release, On – High Illumination
 - Press and hold, Dimming up and down
 - Press and release, Off/On
- 170° adjustable Handle/Stand with magnetic base
- Battery power display function: 3 Color, 4 Segment LED's indicate charge level
- Durable aluminum housing
- Interchangeable, Tool Free, Clamp-on accessory attachment system
- 12 Volt, 1 Amp output AC wall charger with 9ft cord
- 12 Volt, DC, automotive “lighter” type, power port charger with 6ft cord

CONTENTS

- (1) Eastwood Lighting System Light Module on adjustable magnetic base
- (1) Wall Charger – 120V input, 12V, 1 amp output, 9 ft. cord
- (1) 12 Volt DC Power Port Charger – 12V input, 12V 500ma output



SPECIFICATIONS

- 7.4 Volt, 2200mAh, Li-ion type 18650 Integral Rechargeable Battery
- 1000 Lumens light output (high), 100 Lumens light output (lowest dimmer setting)
- 1.5 hours working time (high), 8 hours working time (lowest dimmer setting)
- 10-Watt COB LED
- 3-hour charge time
- Moisture resistant to IP-65 rating
- 1 Meter drop rating

SAFETY INFORMATION

The following explanations are displayed in this manual, on the labeling, and on all other information provided with this product:

DANGER

DANGER indicates a hazardous situation which, if not avoided, will result in death or serious injury.

WARNING

WARNING indicates a hazardous situation which, if not avoided, could result in death or serious injury.

CAUTION

CAUTION used with the safety alert symbol, indicates a hazardous situation which, if not avoided, could result in minor or moderate injury.

NOTICE

NOTICE is used to address practices not related to personal injury.

SAFETY INFORMATION

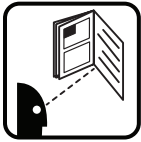

READ INSTRUCTIONS

- Thoroughly read and understand this manual before using.
- Save for future reference.

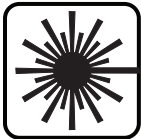

CAUTION EYE INJURY HAZARD!

- Do Not allow LED lamps to project directly into eyes. Temporary blindness may occur.



CAUTION SHOCK HAZARD!

- Keep metal housing of work light away from live electrical sources.
- Never operate or store light in damp or wet conditions.



NOTICE

- Keep work light away from excessive heat sources to avoid damage.

OPERATION

- Grip the Handle/Stand and rotate Lamp through 130° to support or mount lamp magnetically. **NOTE:** The Handle/Stand design allows for quick attachment on the separately available #32401 Eastwood Underhood Bracket (not included) or the #32402 Eastwood Light Tripod (not included).



- Depress and release round Switch located at rear of housing once for Full Brightness and a 2nd time for Off (**FIG 1**).
- Depress and hold Switch in for 3 seconds (lamp will blink twice) to gradually dim lamp (will blink twice again when dimmest setting is reached).
- Depress and release again to turn Off, depress and hold to resume full brightness. **NOTE:** Default setting is Full Brightness. Switching Off and On quickly at any time will return Lamp to Full Brightness.

CHARGING

- When the Lamp fails to illuminate and/or the 4 Tri-Color (Green, Amber & Red) LED charge level segments at the rear of the Housing do not illuminate, a charge is required. Note that the number of illuminated LED's will decrease in number from four to one as the charge depletes.
 - Flip up rubber seal and plug the round terminal of included Wall Charger or 12 Volt Power Port Cable into rear of Housing (**FIG 2**).
 - Plug wall unit into properly grounded 120 VAC, 60 Hz. outlet
 - Allow 3 hours for full charge.
 - The array of 4 Green, Amber and Red LED's at the rear of the Housing will all illuminate to indicate full charge (**FIG 2**).
 - Close Charging Port Cover to maintain IP-65 rating.



CHARGING WHILE IN USE

The Lamp may be used while charging however it will significantly extend the required charging time.

OPTIONAL ACCESSORIES (Not Included)

- #32401 Eastwood Underhood Light Bracket
- #32402 Eastwood Light Tripod
- #32403 Additional Eastwood Light Module Mount

MOUNTING THE LIGHT MODULE ON OPTIONAL ACCESSORIES (Not Included)

MOUNTING TO THE # 32401 EASTWOOD UNDERHOOD LIGHT BRACKET.

- Flip Latches of the sliding Light Module Mount upward (**FIG 3**).
- Slide Magnetic Base of Lamp into sliding Light Module Mount.
- Flip Latches of sliding Light Module Mount downward (**FIG 4**).
- Adjust as required.

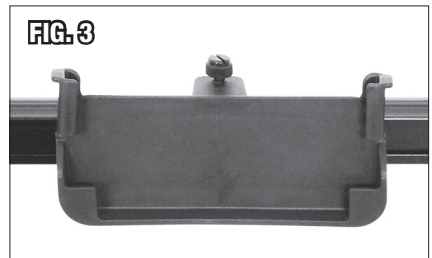

MOUNTING TO THE # 32402 EASTWOOD LIGHT TRIPOD:

- Insert Thumbscrew into Tripod Mounting Plate hole and thread into Magnetic Base of Light Module (**FIG 5**).
- Adjust as required.

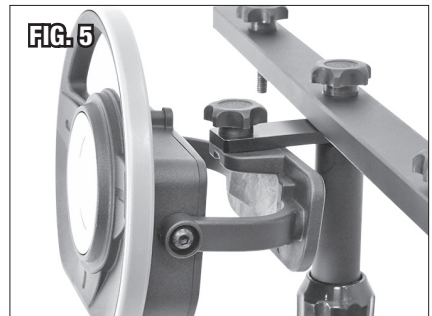
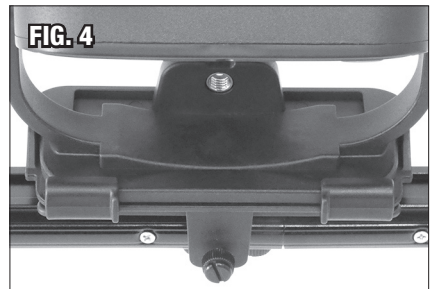

ASSEMBLY OF THE EASTWOOD LIGHTING SYSTEM ACCESSORIES

#32401 EASTWOOD UNDERHOOD LIGHT BRACKET

Consists of:

- (2) Halves of Bracket
- (1) Sliding Light Module Mount
- (2) Thumb Screws

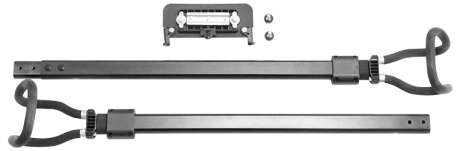

ASSEMBLING THE # 32401 EASTWOOD UNDERHOOD LIGHT BRACKET.

- Insert the rail on the rear of the sliding Light Module Mount into the channel of one half of the Underhood Bracket while simultaneously depressing spring-loaded buttons of the Light Module Mount (**FIG 6**).
- Align the Rubber Covered Hooks and channels of the Underhood Bracket so that they are facing the same direction then slip the open half over the male connector block (**FIG 7**).
- Using two included Thumb Screws, secure the two halves together (**FIG 8**).
- Adjust as required.

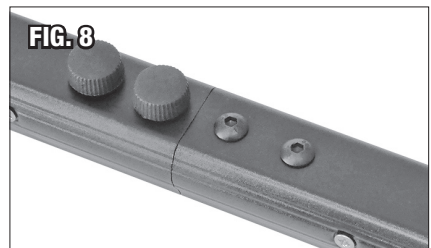
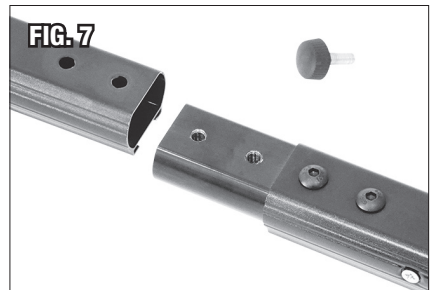
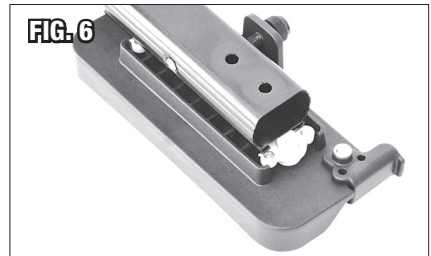

#32402 EASTWOOD LIGHTING SYSTEM TRIPOD

Consists of:

- (1) Tripod
- (1) Long Module Support Bar
- (1) Short Module Support Bar
- (5) Thumb Screws

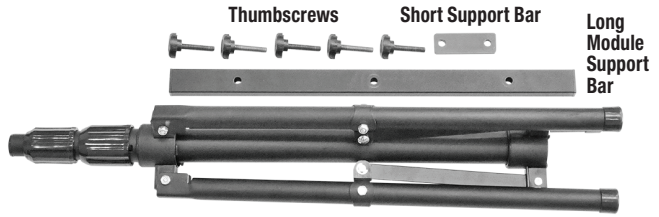

ASSEMBLING THE #32402 EASTWOOD TRIPOD:

- Insert one of the Thumb Screws into the sliding collar attached to the 3-leg assembly and thread it securely into the Main Post and tighten in place (**FIG 9**).
- Using a Thumb Screw, trap the Short Module Support Bar between the Long Module Support Bar and top of the Main Post then thread the Thumbscrew securely into the Main Post (**FIG 9**).
- Pass a Thumb Screw through the open hole in the Light Module Support Bar and thread it into the Magnetic Base of the Light Module (**FIG 9**).
- Adjust as required.
- Utilize the remaining two Thumbscrews to attach additional #32400 Eastwood Light Modules.



If you have any questions about the use of this product, please contact

The Eastwood Technical Assistance Service Department: 800.343.9353 >> email: techelp@eastwood.com

PDF version of this manual is available at eastwood.com

The Eastwood Company 263 Shoemaker Road, Pottstown, PA 19464, USA

800.343.9353 eastwood.com