

AV RECEIVER

Operating Instructions **GB**

Mode d'emploi **FR**

Manual de instrucciones **ES**

Owner's Record

The model and serial numbers are located on the bottom of the unit.

Record the serial number in the space provided below.

Refer to these numbers whenever you call upon your Sony dealer regarding this product.

Model No. XAV-AX5600

Serial No. _____

To cancel the demonstration (Demo) display, see page 7.

Pour annuler l'affichage de démonstration (Démo), reportez-vous à la page 7.

Para cancelar la pantalla de demostración (Demostración), consulte la página 7.



XAV-AX5600(UC)

https://rd1.sony.net/help/ev/xav-ax56/h_zz/



* 5 0 2 5 5 3 5 1 3 * (1)

Warning

For safety, be sure to install this unit in the dashboard of the car as the rear side of the unit becomes hot during use.
For details, see "Connection/Installation" (page 12).

The nameplate indicating operating voltage, etc., is located on the bottom of the chassis.

The validity of the CE marking is restricted to only those countries where it is legally enforced, mainly in the countries EEA (European Economic Area) and Switzerland.

WARNING

To prevent fire or shock hazard, do not expose the unit to rain or moisture.

To avoid electrical shock, do not open the cabinet. Refer servicing to qualified personnel only.

FOR THE CUSTOMERS IN THE USA. NOT APPLICABLE IN CANADA, INCLUDING IN THE PROVINCE OF QUEBEC.

POUR LES CLIENTS AUX ÉTATS-UNIS. NON APPLICABLE AU CANADA, Y COMPRIS LA PROVINCE DE QUÉBEC.

This equipment has been tested and found to comply with the limits for a Class B digital device, pursuant to Part 15 of the FCC Rules. These limits are designed to provide reasonable protection against harmful interference in a residential installation. This equipment generates, uses, and can radiate radio frequency energy and, if not installed and used in accordance with the instructions, may cause harmful interference to radio communications. However, there is no guarantee that interference will not occur in a particular installation. If this equipment does cause harmful interference to radio or television reception, which can be determined by turning the equipment off and on, the user is encouraged to try to correct the interference by one or more of the following measures:

- Reorient or relocate the receiving antenna.
- Increase the separation between the equipment and receiver.
- Connect the equipment into an outlet on a circuit different from that to which the receiver is connected.
- Consult the dealer or an experienced radio/TV technician for help.

You are cautioned that any changes or modifications not expressly approved in this manual could void your authority to operate this equipment.

This device complies with part 15 of FCC Rules and Innovation, Science and Economic Development Canada's licence-exempt RSS(s). Operation is subject to the following two conditions:

- (1) this device may not cause harmful interference, and
- (2) this device must accept any interference received, including interference that may cause undesired operation.

This transmitter must not be co-located or operated in conjunction with any other antenna or transmitter.

This equipment complies with FCC/ISED radiation exposure limits set forth for an uncontrolled environment and meets the FCC radio frequency (RF) Exposure Guidelines and RSS-102 of the ISED radio frequency (RF) Exposure rules as this equipment has very low levels of RF energy.

If you have any questions about this product:

Visit: <https://www.sony.com/electronics/support>

Contact: Sony Customer Information Service Center at 1-800-222-7669

Write: Sony Customer Information Service Center
12451 Gateway Blvd., Fort Myers, FL 33913
Supplier's Declaration of Conformity

Trade Name: SONY
Model: XAV-AX5600

Responsible Party: Sony Electronics Inc.
Address: 16535 Via Esprillo, San Diego, CA 92127
U.S.A.

Telephone Number: [858-942-2230](tel:858-942-2230)

This device complies with part 15 of the FCC rules. Operation is subject to the following two conditions:

- (1) This device may not cause harmful interference, and
- (2) this device must accept any interference received, including interference that may cause undesired operation.

For the State of California, USA only

Perchlorate Material – special handling may apply,
See

www.dtsc.ca.gov/hazardouswaste/perchlorate



**WARNING: Do not ingest battery,
Chemical Burn Hazard.**

The remote commander contains a coin/button cell battery. If the coin/button cell battery is swallowed, it can cause severe internal burns in just 2 hours and can lead to death.

Keep new and used batteries away from children. If the battery compartment does not close securely, stop using the product and keep it away from children.

If you think batteries might have been swallowed or placed inside any part of the body, seek immediate medical attention.

Note on the lithium battery

Do not expose the battery to excessive heat such as direct sunlight, fire or the like.

Warning if your car's ignition has no ACC position

Do not install this unit in a car that has no ACC position. The display of the unit does not turn off even after turning the ignition off, and this causes battery drain.

Disclaimer regarding services offered by third parties

Services offered by third parties may be changed, suspended, or terminated without prior notice. Sony does not bear any responsibility in these sorts of situations.

Important notice

Caution

IN NO EVENT SHALL SONY BE LIABLE FOR ANY INCIDENTAL, INDIRECT OR CONSEQUENTIAL DAMAGES OR OTHER DAMAGES INCLUDING, WITHOUT LIMITATION, LOSS OF PROFITS, LOSS OF REVENUE, LOSS OF DATA, LOSS OF USE OF THE PRODUCT OR ANY ASSOCIATED EQUIPMENT, DOWNTIME, AND PURCHASER'S TIME RELATED TO OR ARISING OUT OF THE USE OF THIS PRODUCT, ITS HARDWARE AND/OR ITS SOFTWARE.

Dear customer, this product includes a radio transmitter.

Please check your vehicle operation manual or contact the manufacturer of your vehicle or your vehicle dealer, before you install this product into your vehicle.

Emergency calls

This BLUETOOTH car handsfree and the electronic device connected to the handsfree operate using radio signals, cellular, and landline networks as well as user-programmed function, which cannot guarantee connection under all conditions. Therefore do not rely solely upon any electronic device for essential communications (such as medical emergencies).

On BLUETOOTH communication

- Microwaves emitting from a BLUETOOTH device may affect the operation of electronic medical devices. Turn off this unit and other BLUETOOTH devices in the following locations, as it may cause an accident.
 - where inflammable gas is present, in a hospital, train, airplane, or petrol station
 - near automatic doors or a fire alarm
- This unit supports security capabilities that comply with the BLUETOOTH standard to provide a secure connection when the BLUETOOTH wireless technology is used, but security may not be enough depending on the setting. Be careful when communicating using BLUETOOTH wireless technology.
- We do not take any responsibility for the leakage of information during BLUETOOTH communication.

If you have any questions or problems concerning your unit that are not covered in this manual, consult your nearest Sony dealer.

Main Unit and Remote Commander

Main unit

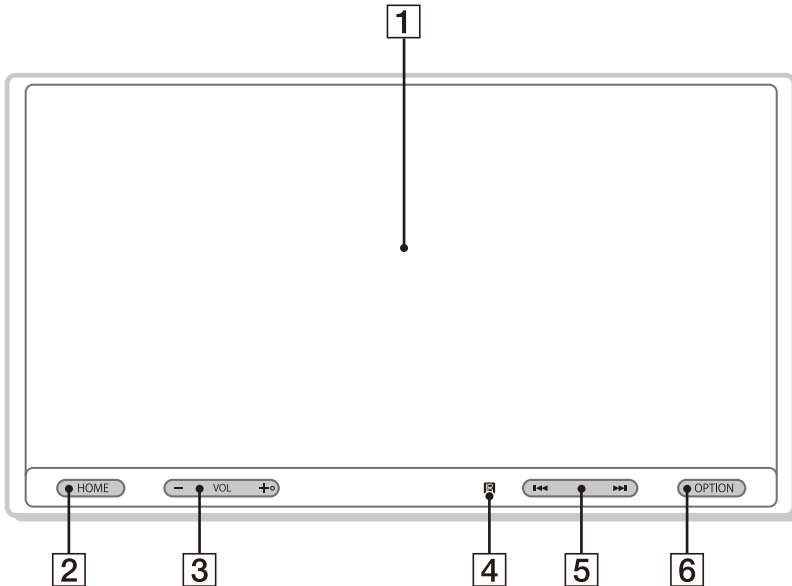

The VOL (volume) + button has a tactile dot.

1 Display/touch screen

2 HOME

Displays the HOME screen (page 6).

● **ATT (attenuate)**

Press and hold for 1 second to attenuate the sound.

To cancel, press and hold again, or press VOL +.

3 VOL (volume) +/-

4 Receptor for the remote commander

5 <</>> (previous/next)

Functions differently depending on the selected source:

- [Radio]: select a preset station.
- [SXM] (SiriusXM): select a preset channel.
- [USB port 1]/[USB port 2]/[Bluetooth]: move to the previous/next file.

Press and hold to:

- [Radio]: tune into a station automatically (SEEK+/SEEK-).
- [USB port 1]/[USB port 2]/[Bluetooth]: fast-reverse/fast-forward.

6 OPTION

Displays the OPTION screen (page 6).

● **VOICE**

Press and hold to activate the voice command function for Apple CarPlay and Android Auto™.

RM-X170 remote commander

The remote commander can be used to operate the audio controls. For menu operations, use the touch screen.

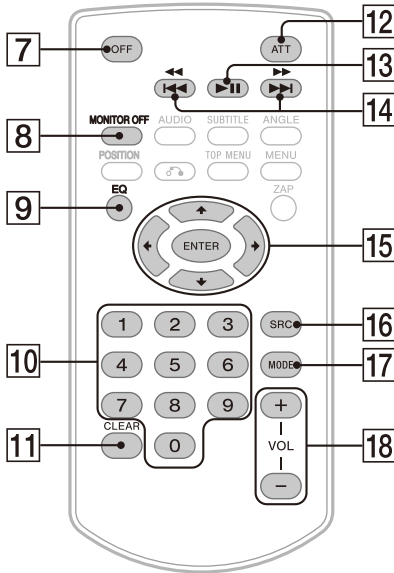

Note

The white buttons in the illustration above are not supported.

- 7 OFF**
Turns the source off.
- 8 MONITOR OFF**
Turns off the monitor.
To turn back on, press again.
- 9 EQ (equalizer)**
Selects an equalizer curve.
- 10 Number buttons (0 to 9)**
- 11 CLEAR**
- 12 ATT (attenuate)**
Attenuates the sound. Press again to cancel the attenuation.
- 13 ►|| (play/pause)**

14 ◀◀/▶▶ (previous/next)

◀◀/▶▶ (fast-reverse/fast-forward)

Functions differently depending on the selected source:

- [Radio]: select a preset station.
- [SXM] (SiriusXM): select a preset channel.
- [USB port 1]/[USB port 2]/[Bluetooth]: move to the previous/next file.

Press and hold to:

- [Radio]: tune into a station automatically (SEEK+/SEEK-).
- [USB port 1]/[USB port 2]/[Bluetooth]: fast-reverse/fast-forward.

15 ◀/▶/◀▶/▶▶

Functions differ depending on the selected source.

- [Radio]: select a preset station or tune into a station automatically.
- [SXM] (SiriusXM): select a preset channel or move to the previous/next channel.
- [USB port 1]/[USB port 2]: select a folder or move to the previous/next file.

ENTER

Enters the selected item.

16 SRC (source)

Changes the source. Each time you press this button, a selectable source is displayed in a popup on the current display.

17 MODE

Selects the radio band.

18 VOL (volume) +/-

Remove the insulation film before use.



Screen displays

Playback screen:

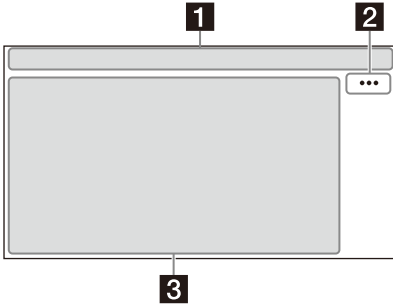

HOME screen:

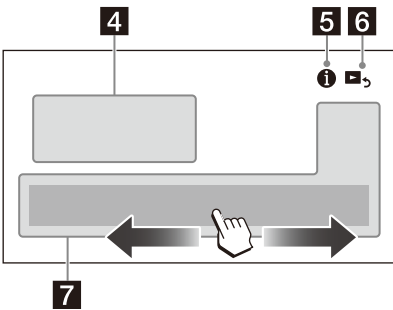

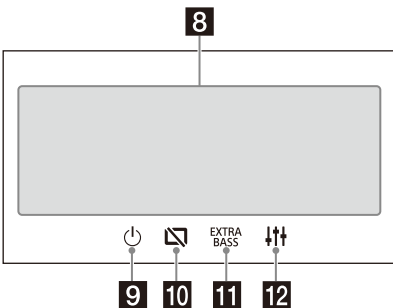

OPTION screen:





1 Status indication

-  Lights up when the sound is attenuated.

-  Indicates the signal strength status of the connected SiriusXM Connect Vehicle Tuner.

-  Lights up when the Bluetooth® signal is on. Flashes when the connection is in progress.

-  Lights up when the audio device is playable by enabling the A2DP (Advanced Audio Distribution Profile).

-  Lights up when handsfree calling is available by enabling the HFP (Handsfree Profile).

-  Indicates the signal strength status of the connected mobile phone.

-  Indicates the remaining battery status of the connected mobile phone.

2 ... (source option)

Opens the source option menu. The available items differ depending on the source.

3 Application specific area

Displays playback controls/indications or show the unit's status. Displayed items differ depending on the source.

4 Clock

Displays the time which are set on the Date/Time setting.

5 i (instruction for smartphone connection)













Displays the instruction for connecting Apple CarPlay, Android Auto or WebLink™.

6 ↶ (return to the playback screen)

Switches from the HOME screen to the playback screen.

7 Sources and Settings select keys

Changes the source or make various settings. Flick to select the setting icon and other icons. Touch the source icon you want to select.

	Android Auto		Apple CarPlay		Radio
	SXM		Bluetooth		HDMI
	Rear Camera		USB port 1		WebLink
	USB port 2		Phone		Settings

8 Sound select keys

Changes the sound.

9 (standby)

Turns the unit in standby mode (USB charging is still available). To resume, press any buttons.

10 (monitor off)

Turns off the monitor. When the monitor is turned off, touch any part of the display to turn it back on.

11 (EXTRA BASS)

Changes the EXTRA BASS setting.

12 (EQ10/Subwoofer)

Changes the EQ10/Subwoofer setting.

Basic Operations

Pairing with a BLUETOOTH Device

When connecting a BLUETOOTH device for the first time, mutual registration (called "pairing") is required. Pairing enables this unit and other devices to recognize each other.

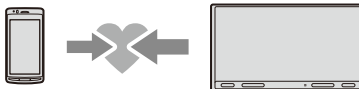

- 1 Press HOME, then touch [Settings] → [Bluetooth] → [Bluetooth Connection] → [ON] → [Pairing].
 flashes while the unit is in pairing standby mode.
- 2 Perform pairing on the BLUETOOTH device so it detects this unit.
- 3 Select your model name shown on the display of the BLUETOOTH device*.

When pairing is made,  stays lit.

* If passkey input is required on the BLUETOOTH device, input [0000].

Connecting Rear View Camera

By connecting the optional rear view camera to the CAMERA IN terminal, you can display the picture from the rear view camera. For details, see "Connection/Installation" (page 12).

To display the picture from the rear view camera

Press HOME, then touch [Rear Camera].

Canceling the Demonstration Mode

- 1 Press HOME, then touch [Settings].
- 2 Touch [General], then touch [Demo] to set to [OFF].
- 3 To exit the setup menu, touch  (back) twice.

Updating the Firmware

To update the firmware, visit the support site, then follow the online instructions.

URL: <https://www.sony.com/am/support>

Notes

- During the update, do not remove the USB device.
- You will need to insert the USB device to USB port 1, then switch to USB port 2 following the on-screen guidance.

Additional Information

Precautions

- Power antenna (aerial) extends automatically.
- When you transfer ownership or dispose of your car with the unit installed, initialize all the settings to the factory settings by performing the factory reset.
- Do not splash liquid onto the unit.

Notes on safety

- Comply with your local traffic rules, laws, and regulations.
- While driving
 - Do not watch or operate the unit, as it may lead to distraction and cause an accident. Park your car in a safe place to watch or operate the unit.
 - Do not use the setup feature or any other function which could divert your attention from the road.
 - When backing up your car, be sure to look back and watch the surroundings carefully for your safety even if the rear view camera is connected. Do not depend on the rear view camera exclusively.
- While operating
 - Do not insert your hands, fingers, or foreign objects into the unit as it may cause injury or damage to the unit.
 - Keep small articles out of the reach of children.
 - Be sure to fasten seatbelts to avoid injury in the event of sudden movement of the car.

Preventing an accident

Pictures appear only after you park the car and set the parking brake.

If the car starts moving during video playback, the following caution is displayed and you cannot watch the video.

[Video blocked for your safety.]

Do not operate the unit or watch the monitor while driving.

Notes on LCD panel

- Do not get the LCD panel wet or expose it to liquids. This may cause a malfunction.
- Do not press down hard on the LCD panel as doing so can distort the picture or cause a malfunction (i.e., the picture may become unclear or the LCD panel may be damaged).
- Do not touch the panel with objects other than with your finger as it may damage or break the LCD panel.
- Clean the LCD panel with a dry soft cloth. Do not use solvents such as benzine, thinner, commercially available cleaners, or antistatic spray.
- Do not use the unit outside the temperature range 0 °C to 40 °C (32 °F to 104 °F).
- If your car was parked in a cold or hot place, the picture may not be clear. However, the monitor is not damaged and the picture will become clear after the temperature in your car becomes normal.
- Some stationary blue, red, or green dots may appear on the monitor. These are called “bright spots” and can happen with any LCD. The LCD panel is precision-manufactured with more than 99.99% of its segments functional. However, it is possible that a small percentage (typically 0.01%) of the segments may not light up properly. This will not, however, interfere with your viewing.



Notes on the touch screen

- This unit uses a capacitive touch screen. Touch the screen directly with your fingertip.
- Multi-touch operation is not supported on this unit.
- Do not touch the screen with sharp objects such as a needle, pen, or fingernail. Operation with a stylus is not supported on this unit.
- Touching the screen with a gloved finger may cause the unit to operate incorrectly or not respond.
- Do not let any objects contact the touch screen. If the screen is touched by an object other than your fingertip, the unit may not respond correctly.
- Since glass material is used for the screen, do not subject the unit to strong shock. If cracking or chipping occurs on the screen, do not touch the damaged part as it may cause injury.
- Keep other electrical devices away from the touch screen. They may cause the touch screen to malfunction.
- If there are water droplets on the touch screen, or if you touch the screen with wet fingertips, the touch screen may not react correctly.

About iPhone

• Compatible iPhone models:

- iPhone SE (2nd generation), iPhone 11 Pro Max, iPhone 11 Pro, iPhone 11, iPhone XS Max, iPhone XS, iPhone XR, iPhone X, iPhone 8 Plus, iPhone 8, iPhone 7 Plus, iPhone 7, iPhone SE, iPhone 6s Plus, iPhone 6s, iPhone 6 Plus, iPhone 6, iPhone 5s
- Use of the Made for Apple badge means that an accessory has been designed to connect specifically to the Apple product(s) identified in the badge, and has been certified by the developer to meet Apple performance standards. Apple is not responsible for the operation of this device or its compliance with safety and regulatory standards. Please note that the use of this accessory with an Apple product may affect wireless performance.

Notice on license

This product contains software that Sony uses under a licensing agreement with the owner of its copyright. We are obligated to announce the contents of the agreement to customers under requirement by the owner of copyright for the software.

For details on software licenses, select [Settings] → [General] → [Open Source Licenses].

Notice on GNU GPL/LGPL applied software

This product contains software that is subject to the following GNU General Public License (hereinafter referred to as “GPL”) or GNU Lesser General Public License (hereinafter referred to as “LGPL”). These establish that customers have the right to acquire, modify, and redistribute the source code of said software in accordance with the terms of the GPL or LGPL displayed on this unit.

The source code for the above-listed software is available on the Web.

To download, please access the following URL then select the model name “XAV-AX5600.”

URL: <http://www.sony.net/Products/Linux/>

Please note that Sony cannot answer or respond to any inquiries regarding the content of the source code.

If you have any questions or problems concerning your unit that are not covered in this Operating Instructions, consult your nearest Sony dealer.

Maintenance

Replacing the lithium battery (CR2025) of the remote commander

When the battery becomes weak, the range of the remote commander becomes shorter.

CAUTION

Danger of explosion if battery is incorrectly replaced. Replace only with the same or equivalent type.

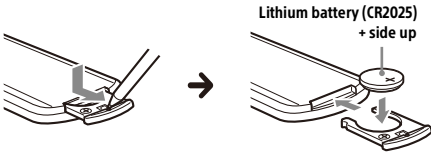

Note on the lithium battery

Keep the lithium battery out of the reach of children. Should the battery be swallowed, immediately consult a doctor.

Specifications

FOR THE CUSTOMERS IN THE USA. NOT APPLICABLE IN CANADA, INCLUDING IN THE PROVINCE OF QUEBEC.

POUR LES CLIENTS AUX ÉTATS-UNIS. NON APPLICABLE AU CANADA, Y COMPRIS LA PROVINCE DE QUÉBEC.

AUDIO POWER SPECIFICATIONS



CTA2006 Standard

Power Output: 20 Watts RMS × 4 at 4 Ohms < 1% THD+N

SN Ratio: 80 dBA (reference: 1 Watt into 4 Ohms)

Monitor section

Display type: Wide LCD color monitor

Dimensions: 6.95 in/176 mm

System: TFT active matrix

Number of pixels:

1,152,000 pixels (800 × 3 (RGB) × 480)

Color system:

PAL/NTSC automatic select for CAMERA IN terminal

Radio section

FM

Tuning range: 87.5 MHz – 107.9 MHz

Usable sensitivity: 7 dBf

Signal-to-noise ratio: 70 dB (mono)

Separation at 1 kHz: 45 dB

AM

Tuning range: 530 kHz – 1,710 kHz

Sensitivity: 32 μV

USB player section

Interface:

USB port 1 (Hi-speed)

USB port 2 (Full-speed)

Maximum current:

USB port 1: 1.5 A

USB port 2: 500 mA

HDMI section*

Input format: 480p, 576p, 720p

* HDMI output is not available.

Wireless communication

Communication System:

BLUETOOTH Standard version 3.0

Output:

BLUETOOTH Standard Power Class 2

(Max. Conducted +1 dBm)

Maximum communication range*1:

Line of sight approx. 10 m (33 ft)

Frequency band:

2.4 GHz band (2.4000 GHz – 2.4835 GHz)

Modulation method: FHSS

Compatible BLUETOOTH Profiles*2:

- A2DP (Advanced Audio Distribution Profile) 1.3
- AVRCP (Audio Video Remote Control Profile) 1.3
- HFP (Handsfree Profile) 1.6
- PBAP (Phone Book Access Profile) 1.1

Corresponding codec: SBC, AAC

*1 The actual range will vary depending on factors such as obstacles between devices, magnetic fields around a microwave oven, static electricity, reception sensitivity, antenna (aerial) performance, operating system, software application, etc.

*2 BLUETOOTH standard profiles indicate the purpose of BLUETOOTH communication between devices.

Power amplifier section

Outputs: Speaker outputs

Speaker impedance: 4 Ω – 8 Ω

Maximum power output: 55 W \times 4 (at 4 Ω)

General

Power requirements: 12 V DC car battery
(negative ground (earth))

Rated current consumption: 10 A

Dimensions:

Approx. 178 mm \times 100 mm \times 139 mm
(7 1/8 in \times 4 in \times 5 1/2 in) (w/h/d)

Mounting dimensions:

Approx. 182 mm \times 111 mm \times 120 mm
(7 1/4 in \times 4 3/8 in \times 4 3/4 in) (w/h/d)

Mass: Approx. 1.0 kg (2 lb 4 oz)

Package contents:

- Main unit (1)
- Parts for installation and connections (1 set)
- Remote Commander (1): RM-X170

Optional accessories/equipment:

- SiriusXM Connect Vehicle Tuner: SXV100, SXV200, SXV300

Ask the dealer for detailed information.

Design and specifications are subject to change without notice.

Copyrights



SiriusXM-Ready® allows you to Listen to ad-free music, plus all the sports, talk, comedy, news coverage, all in one place. (SiriusXM Connect Tuner and subscription required. Sold separately.) For more information, visit www.siriusxm.com. Sirius, XM and all related marks and logos are trademarks of Sirius XM Radio Inc. All rights reserved.

The Bluetooth® word mark and logos are registered trademarks owned by Bluetooth SIG, Inc. and any use of such marks by Sony Corporation is under license. Other trademarks and trade names are those of their respective owners.

Windows Media is either a registered trademark or trademark of Microsoft Corporation in the United States and/or other countries.

This product is protected by certain intellectual property rights of Microsoft Corporation. Use or distribution of such technology outside of this product is prohibited without a license from Microsoft or an authorized Microsoft subsidiary.

Apple and iPhone are trademarks of Apple Inc., registered in the U.S. and other countries. Apple CarPlay is a trademark of Apple Inc.

Android Auto is a trademark of Google LLC.

WebLink is a registered trademark of Abalta Technologies, Inc. in the U.S. and a trademark in the other countries.

The terms HDMI, HDMI High-Definition Multimedia Interface, and the HDMI Logo are trademarks or registered trademarks of HDMI Licensing Administrator, Inc.

All other trademarks are trademarks of their respective owners.

Cautions

- Do not install this unit in a car that has no ACC position. The display of the unit does not turn off even after turning the ignition off, and this causes battery drain.
- **Run all ground (earth) leads to a common ground (earth) point.**
- Do not get the leads trapped under a screw or caught in moving parts (e.g., seat railing).
- Before making connections, turn the car ignition off to avoid short circuits.
- Connect the **yellow** and **red** power supply leads only after all other leads have been connected.
- Be sure to insulate any loose unconnected leads with electrical tape for safety.
- Choose the installation location carefully so that the unit will not interfere with normal driving operations.
- Avoid installing the unit in areas subject to dust, dirt, excessive vibration, or high temperature, such as in direct sunlight or near heater ducts.
- Use only the supplied mounting hardware for a safe and secure installation.

Note on the power supply lead (yellow)

When connecting this unit in combination with other stereo components, the amperage rating of the car circuit to which the unit is connected must be higher than the sum of each component's fuse amperage rating.

Note on installing in cars with a start-stop system

The unit may restart when starting the engine from start-stop. In this case, turn off the start-stop system of your car.

Note on installing in cars with electric parking brake system

For cars with electric parking brakes, some related functions (such as video blocking function) may not work properly.

Mounting angle adjustment

Adjust the mounting angle to less than 30°.

Parts List for Installation

① Power supply leads (1)



② Mounting screw
(5 × max. 9 mm
(7/32 × max. 3/8 in)) (4)



③ Microphone (1)



④ Flat-mount base (1)



⑤ Double-sided tape (1)



⑥ USB extension cable (1)



⑦ Cable tie (1)



⑧ Connection cable RC-SR1 (1)



⑨ Cable tie (1)



This parts list does not include all the package contents.

Connection

- To prevent short circuits, insulate leads with a cover or tape.
- Note that the unit may be damaged if it is connected incorrectly or by short circuits at the leads.

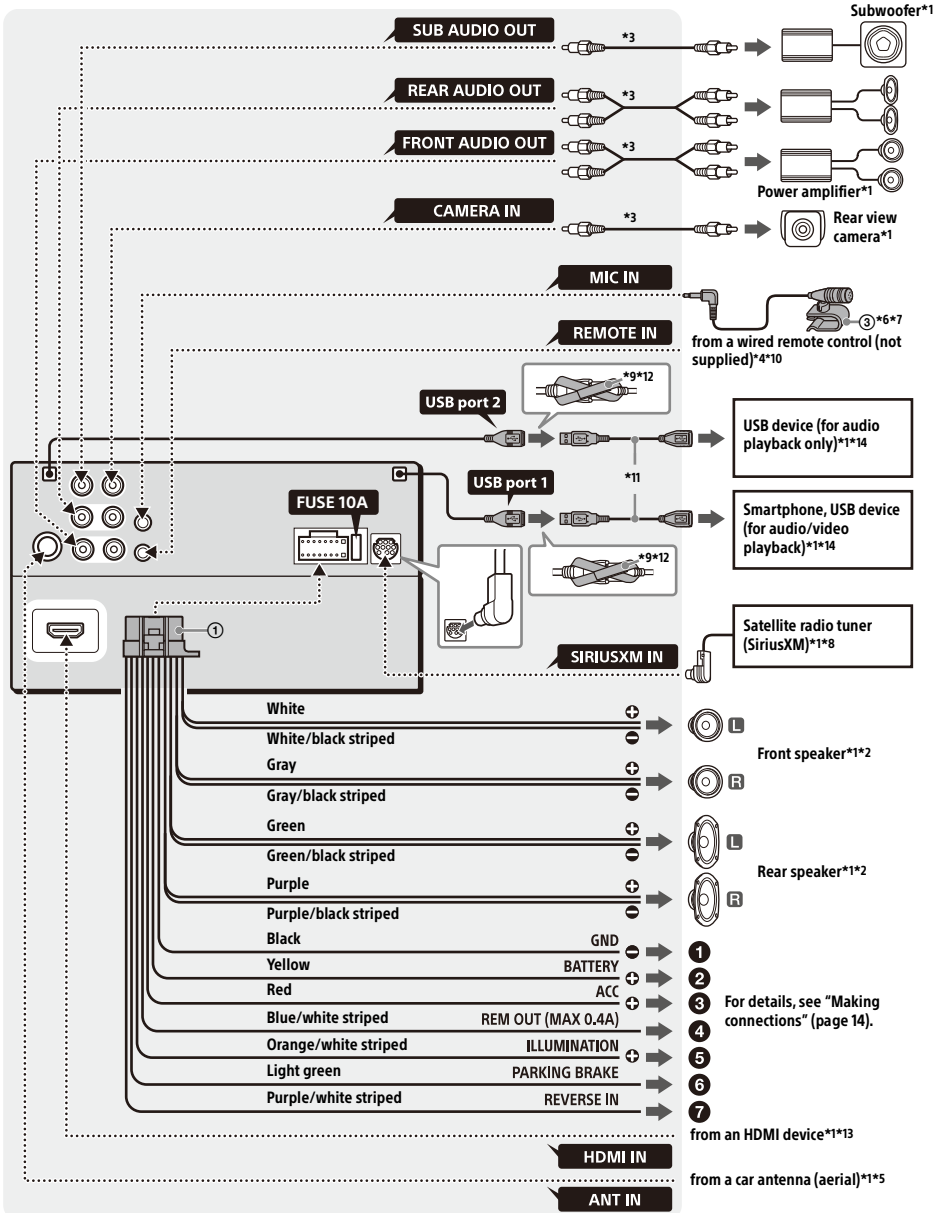

- *1 Not supplied
- *2 Speaker impedance: $4\ \Omega$ to $8\ \Omega \times 4$
- *3 RCA pin cord (not supplied)
- *4 Depending on the type of car, use an adaptor for a wired remote control (not supplied).
For details on using the wired remote control, see "Using the wired remote control" (page 15).
- *5 Depending on the type of car, use an adaptor (not supplied) if the antenna (aerial) connector does not fit.
- *6 Whether in use or not, route the microphone input cord so it does not interfere with driving operations. Secure the cord with a clamp, etc., if it is installed around your feet.
- *7 For details on installing the microphone, see "Installing the microphone" (page 14).
- *8 For more information on how to install the SiriusXM Connect Vehicle Tuner, consult the installation guide included with the tuner.



- *9 **10** When using the steering wheel remote control, use the connection cable RC-SR1 **10** as necessary.
- *11 Use the USB extension cable **11** or a commercially available one.
- *12 Use the cable tie **12** or a commercially available one.
- *13 For details on using an HDMI device, see "Using an HDMI device" (page 15).
- *14 When updating the firmware, insert the USB device to USB port 1, then switch to USB port 2 following the on-screen guidance.

Making connections

1 To a common ground (earth) point

First connect the black ground (earth) lead then connect the yellow and red power supply leads.

2 To the +12 V power terminal which is energized at all times

Be sure to first connect the black ground (earth) lead to a common ground (earth) point.

3 To the +12 V power terminal which is energized when the ignition switch is set to the accessory position

Be sure to first connect the black ground (earth) lead to a common ground (earth) point.

4 To the power antenna (aerial) control lead or the power supply lead of the antenna (aerial) booster

It is not necessary to connect this lead if there is no power antenna (aerial) or antenna (aerial) booster, or with a manually-operated telescopic antenna (aerial).

To AMP REMOTE IN of an optional power amplifier

This connection is only for amplifiers and a power antenna (aerial). Connecting any other system may damage the unit.

Note

It will take about 10 seconds to shut down the output of REM OUT after the unit is turned off.

5 To a car's illumination signal

Be sure to first connect the black ground (earth) lead to a common ground (earth) point.

6 To the parking brake switch lead

The mounting position of the parking brake switch lead depends on your car. Be sure to connect the parking brake lead (light green) of the power supply leads **1** to the parking brake switch lead.

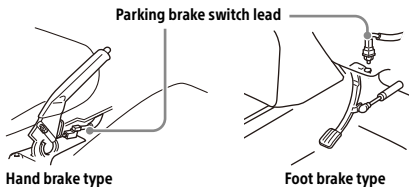

7 To the +12 V power terminal of the car's rear lamp lead (only when connecting the rear view camera)

Memory hold connection

When the yellow power supply lead is connected, power will always be supplied to the memory circuit even when the ignition switch is turned off.

Speaker connection

- Before connecting the speakers, turn the unit off.
- Use speakers with an impedance of $4\ \Omega$ to $8\ \Omega$ and with adequate power handling capacities to avoid damage.

Installing the microphone

To capture your voice during handsfree calling, you need to install the microphone **3**.

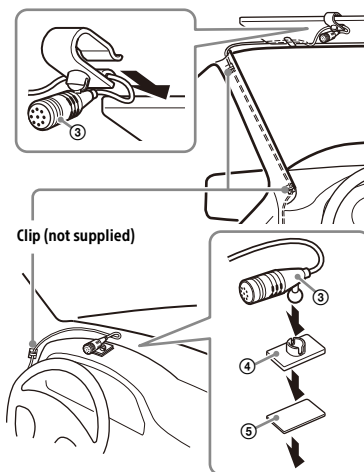

Cautions

- It is extremely dangerous if the cord becomes wound around the steering column or gearstick. Be sure to keep it and other parts from interfering with your driving operations.
- If airbags or any other shock-absorbing equipment are in your car, contact the store where you purchased this unit or the car dealer before installation.

Notes

- When mounting on the dashboard, remove the visor clip carefully from the microphone (3), then attach the flat-mount base (4) to the microphone (3).
- Before attaching the double-sided tape (5), clean the surface of the dashboard with a dry cloth.

Using the wired remote control

When using the steering wheel remote control

Installation of the connection cable RC-SR1 (8) is required before use.

- 1 To enable the steering wheel remote control, select [General] → [Steering Control] → [Custom] →  to make the registration.
When the registration is complete, the steering wheel remote control becomes available.

Notes on installing the connection cable RC-SR1 (8)

- Refer to the support site for details then connect each lead properly to the appropriate leads. Making an improper connection may damage the unit.
URL: <https://www.sony.com/am/support>
- Consulting the dealer or an experienced technician for help is recommended.

When using the wired remote control

- 1 To enable the wired remote control, set [Steering Control] in [General] to [Preset].

Using an HDMI device

Installation of an HDMI cable (not supplied) is required before use.

- 1 Connect an HDMI cable to the HDMI terminal at the back panel of the unit.
- 2 Pass the cable tie (9) through the cable holder, then tie the cable tie (9) around the HDMI cable.

The HDMI cable is secured to the unit.

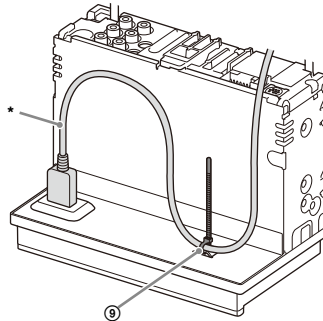

* HDMI cable (not supplied)

- 3 Connect the installed HDMI cable to an HDMI device.
- 4 Press HOME, then touch [HDMI].
The HDMI device connected will be mirrored to this unit.

Using the rear view camera

Installation of the rear view camera (not supplied) is required before use.

The picture from a rear view camera connected to the CAMERA IN terminal is displayed when:

- the back lamp of your car lights up (or the shift lever is set to the R (reverse) position).
- you press HOME, then touch [Rear Camera].

Installation

Mounting the unit in a Japanese car

You may not be able to install this unit in some Japanese cars. In such a case, consult your Sony dealer.

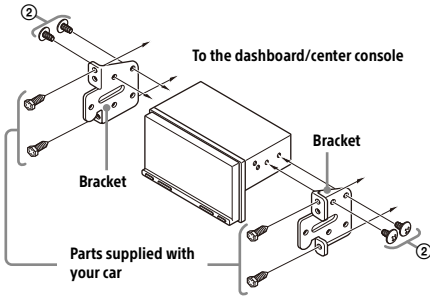

When mounting this unit to the preinstalled brackets of your car, use the mounting screws ② in the appropriate screw holes based on your car: T for TOYOTA and N for NISSAN.

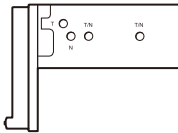

Note

To prevent a malfunction, install only with the mounting screws ②.

Fuse replacement

When replacing the fuse, be sure to use one matching the amperage rating stated on the original fuse. If the fuse blows, check the power connection and replace the fuse. If the fuse blows again after replacement, there may be an internal malfunction. In such a case, consult your nearest Sony dealer.

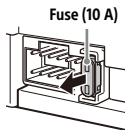

**If you have any questions/problems regarding
this product, try the following:**

- 1 Read Troubleshooting in
Help Guide (online manual).**
- 2 Please contact (U.S.A. only);**
Call **1-800-222-7669**
URL **<https://www.SONY.com>**



In-Car Receiver
XAV-AX5600/XAV-AX5650



Use this manual if you encounter any problems, or have any questions.

Note: The picture above is for the North America region. Actual product may vary depending on the region.

Getting Started

Guide to Parts and Controls

[Main Unit and Remote Commander](#)

[Screen Displays](#)

[Performing Initial Settings](#)

Preparing a BLUETOOTH Device

[Preparing a Bluetooth® Device](#)

[Pairing and Connecting with a BLUETOOTH Device](#)

[Connecting with a Paired BLUETOOTH Device](#)

[Connecting Rear View Camera](#)

Radio

Listening to the Radio

- [Listening to the Radio](#)
- [Tuning](#)
- [Using Radio Option Functions](#)

Listening to the SiriusXM Radio (XAV-AX5600(UC))

- [Listening to the SiriusXM Radio](#)
- [Tuning Channels for SiriusXM](#)
- [Tuning the Channel by Inputting its Channel Number](#)
- [Tuning the Channel from the Channel List or Category List](#)
- [Setting a Parental Control](#)
- [Using SXM Option Functions](#)

Listening to the DAB/DAB+ Radio (XAV-AX5650(EUR))

- [Listening to the DAB/DAB+ Radio](#)
- [Searching for Station by Station Group](#)
- [Searching for Station by Station Name](#)
- [Using DAB Option Functions](#)

Playback

Playing a USB Device

- [Playing a USB Device](#)
- [USB Port 1 and USB Port 2](#)

[Playing an HDMI™ Device](#)

[Playing a BLUETOOTH Device](#)

Searching and Playing Tracks

- [Repeat Play and Shuffle Play](#)
- [Searching for a File from the List Screen](#)

[Other Settings during Playback](#)

Handsfree Calling

[Preparing a Mobile Phone](#)

[Receiving a Call](#)

[Making a Call](#)

[Available Operations during a Call](#)

Useful Functions

[Apple CarPlay](#)

[Android Auto™](#)

[WebLink™](#)

[Using Gesture Command](#)

Settings

[Basic Setting Operation](#)

[General Settings \(General\)](#)

[Sound Settings \(Sound\)](#)

[Visual Settings \(Visual\)](#)

[BLUETOOTH Settings \(Bluetooth\)](#)

Additional Information

[Canceling the Demonstration Mode](#)

[Updating the Firmware](#)

[Precautions](#)

[Supported Formats for USB Playback](#)

[About iPhone](#)

[Notice on License](#)

[Maintenance](#)

[Specifications](#)

[Copyrights](#)

Troubleshooting

[Troubleshooting](#)

General

- [There is no beep sound.](#)
- [The fuse has blown. / The unit makes noise when the position of the ignition is switched.](#)
- [The display disappears from/does not appear on the monitor.](#)

- [Menu items cannot be selected.](#)
- [The USB functions do not work properly.](#)
- [The unit cannot be operated.](#)
- [The clock set automatically is not accurate.](#)

Touch Screen

- [The touch screen does not react to your touch correctly.](#)
- [Multi-touch is not recognized.](#)

Radio

- [The radio reception is poor. / Static noise occurs.](#)

RDS

- [PTY displays \[PTY not found.\].](#)
- [Seek starts after a few seconds of listening. \(XAV-AX5650\(EUR\)\).](#)
- [There are no traffic announcements. \(XAV-AX5650\(EUR\)\).](#)

DAB/DAB+ radio (XAV-AX5650(EUR))

- [Stations cannot be received.](#)
- [No traffic announcements.](#)

Picture

- [There is no picture or picture noise occurs.](#)
- [The picture does not fit in the screen.](#)

Sound

- [There is no sound, sound skips, or sound cracks.](#)
- [Sound is noisy.](#)

USB playback

- [Items cannot be played.](#)
- [The USB device takes longer to play.](#)
- [Audio files cannot be played.](#)
- [Operations cannot be performed.](#)

HDMI playback

- [The connected HDMI device cannot be played.](#)

BLUETOOTH

- [The other BLUETOOTH device cannot detect this unit.](#)
- [Connection is not possible.](#)
- [The name of the detected device does not appear.](#)
- [There is no ringtone.](#)
- [The talker's voice volume is low.](#)
- [The other party says that the volume is too low or high.](#)
- [Echo or noise occurs during call conversations.](#)
- [The phone sound quality is poor.](#)
- [The volume of the connected BLUETOOTH device is low or high.](#)
- [The sound skips during audio streaming or the BLUETOOTH connection fails.](#)
- [The connected BLUETOOTH device cannot be controlled during audio streaming.](#)
- [Some functions do not work.](#)
- [A call is answered unintentionally.](#)
- [Pairing failed due to time out.](#)
- [Cannot pair.](#)
- [The BLUETOOTH function cannot be operated.](#)
- [No sound is output from the car speakers during a handsfree call.](#)

SiriusXM Connect Vehicle Tuner (XAV-AX5600(UC))

- [A mature channel is not blocked although parental control setting has been made.](#)

Apple CarPlay

- [The Apple CarPlay icon does not appear on the HOME screen.](#)

Android Auto

- [The Android Auto icon does not appear on the HOME screen.](#)

WebLink™

- [WebLink™ cannot be used.](#)
- [There is no sound. / The sound is low.](#)

Messages

- [General](#)
- [BLUETOOTH](#)
- [SiriusXM Connect Vehicle Tuner \(XAV-AX5600\(UC\)\)](#)

[WebLink™](#)

[DAB radio \(XAV-AX5650\(EUR\)\),](#)

Support Websites

[Customer Support Websites](#)

[About the “Support by Sony” App](#)

5-025-746-11(2) Copyright 2021 Sony Corporation

In-Car Receiver
XAV-AX5600/XAV-AX5650

Main Unit and Remote Commander

Main unit

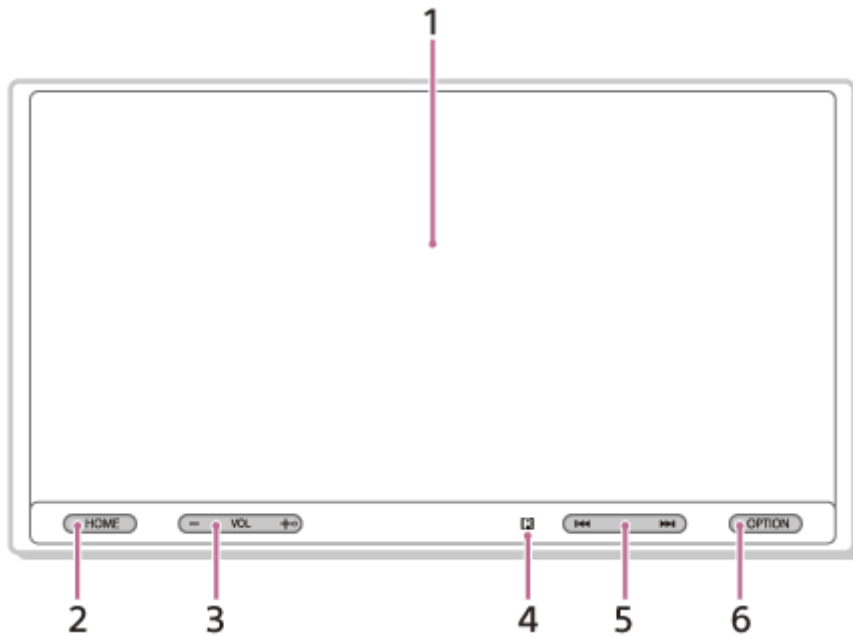

The VOL (volume) + button has a tactile dot.

RM-X170 remote commander (XAV-AX5600(UC))

The remote commander can be used to operate the audio controls. For menu operations, use the touch screen.

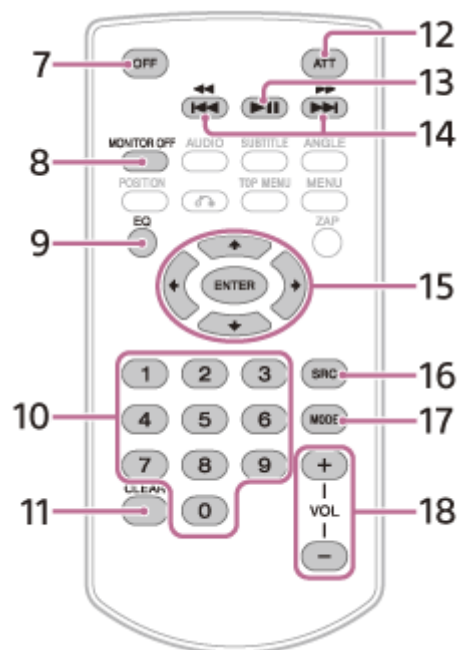

Note

- The white buttons in the illustration above are not supported.

Remove the insulation film before use.



1. Display/touch screen

2. HOME

Displays the HOME screen.

● ATT (attenuate)

Press and hold for 1 second to attenuate the sound.

To cancel, press and hold again, or press VOL +.

3. VOL (volume) +/-

4. Receptor for the remote commander

5. ◀◀ / ▶▶ (previous/next)

Functions differently depending on the selected source:

[Radio]: select a preset station.

[SXM] (SiriusXM): select a preset channel. (XAV-AX5600(UC))

[DAB+]: select a preset station. (XAV-AX5650(EUR))

[USB port 1]/[USB port 2]: move to the previous/next file.

[Bluetooth]: move to the previous/next file.

Press and hold to:

[Radio]: tune into a station automatically (SEEK+/SEEK-).

[DAB+]: select a station (when [Seek By] is set to [A-Z])/search for a station (when [Seek By] is set to [Station Gp]).

(XAV-AX5650(EUR))

[USB port 1]/[USB port 2]: fast-reverse/fast-forward.

[Bluetooth]: fast-reverse/fast-forward.

6. OPTION

Displays the OPTION screen.

● VOICE

Press and hold to activate the voice command function for Apple CarPlay and Android Auto.

7. OFF

Turns the source off.

8. MONITOR OFF

Turns off the monitor.

To turn back on, press again.

9. EQ (equalizer)

Selects an equalizer curve.

10. Number buttons (0 to 9)

11. CLEAR

12. ATT (attenuate)

Attenuates the sound. Press again to cancel the attenuation.

13. ▶|| (play/pause)

14. ◀◀ / ▶▶ (previous/next)

◀◀ / ▶▶ (fast-reverse/fast-forward)

Functions differently depending on the selected source:

[Radio]: select a preset station.

[SXM] (SiriusXM): select a preset channel. (XAV-AX5600(UC))

[DAB+]: select a preset station. (XAV-AX5650(EUR))

[USB port 1]/[USB port 2]: move to the previous/next file.

[Bluetooth]: move to the previous/next file.

Press and hold to:

[Radio]: tune into a station automatically (SEEK+/SEEK-).

[DAB+]: select a station (when [Seek By] is set to [A-Z])/search for a station (when [Seek By] is set to [Station Gp]).

(XAV-AX5650(EUR))

[USB port 1]/[USB port 2]: fast-reverse/fast-forward.

[Bluetooth]: fast-reverse/fast-forward.

15. ◀ / ↑ / ↓ / ▶ (left/up/down/right)

Functions differ depending on the selected source.

[Radio]: select a preset station or tune into a station automatically.

[SXM] (SiriusXM): select a preset channel or move to the previous/next channel. (XAV-AX5600(UC))

[USB port 1]/[USB port 2]: select a folder or move to the previous/next file.

ENTER

Enters the selected item.

16. SRC (source)

Changes the source. Each time you press this button, a selectable source is displayed in a popup on the current display.

17. MODE

Selects the radio band.

18. VOL (volume) +/-

Related Topic

- [Screen Displays](#)

In-Car Receiver
XAV-AX5600/XAV-AX5650

Screen Displays

Playback screen:

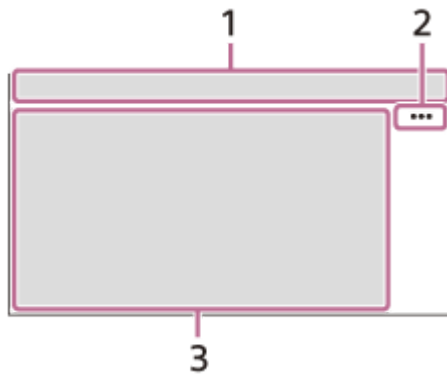

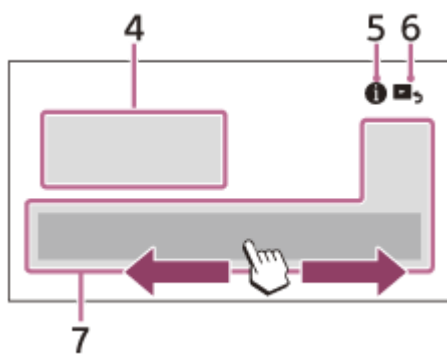

HOME screen:



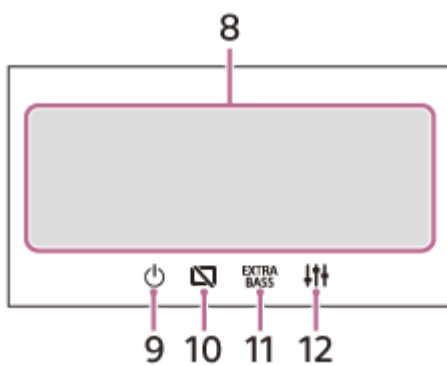







OPTION screen:



1. Status indication

Icon in the display	Detail
 ATT (attenuate)	Lights up when the sound is attenuated.
 AF (Alternative Frequencies)	Lights up when AF (Alternative Frequencies) is available. (XAV-AX5650(EUR))

Icon in the display	Detail
 (Traffic Announcement)	Lights up when the current traffic information (TA: Traffic Announcement) is available. (XAV-AX5650(EUR))
 (DAB announcement)	Lights up when a DAB announcement is available. (XAV-AX5650(EUR))
 (DAB)	Indicates the signal strength status of the DAB radio. (XAV-AX5650(EUR))
 (SiriusXM)	Indicates the signal strength status of the connected SiriusXM Connect Vehicle Tuner. (XAV-AX5600(UC))
 (BLUETOOTH)	Lights up when the BLUETOOTH signal is on. Flashes when the connection is in progress.
 (audio)	Lights up when the audio device is playable by enabling the A2DP (Advanced Audio Distribution Profile).
 (mobile phone)	Lights up when handsfree calling is available by enabling the HFP (Handsfree Profile).
 (antenna)	Indicates the signal strength status of the connected mobile phone.
 (battery)	Indicates the remaining battery status of the connected mobile phone.

2. ●●● (source option)

Opens the source option menu. The available items differ depending on the source.

3. Application specific area

Displays playback controls/indications or show the unit's status. Displayed items differ depending on the source.

4. Clock

Displays the time which are set on the Date/Time setting.

5. ⓘ (instruction for smartphone connection) (XAV-AX5600(UC))

Displays the instruction for connecting Apple CarPlay, Android Auto or WebLink™.

6. 🏠 (return to the playback screen)

Switches from the HOME screen to the playback screen.

7. Sources and Settings select keys









Changes the source or make various settings.

Flick to select the setting icon and other icons.













Touch the source icon you want to select.

XAV-AX5600(UC):

Icon in the display	Name
	Android Auto
	Apple CarPlay
	Radio
	SXM

Icon in the display	Name
	Bluetooth
	HDMI
	Rear Camera
	USB port 1
	WebLink
	USB port 2
	Phone
	Settings

XAV-AX5650(EUR):

Icon in the display	Name
	Android Auto
	Apple CarPlay
	Radio
	DAB+
	Bluetooth
	Phone
	USB port 1
	WebLink
	USB port 2
	HDMI
	Rear Camera
	Settings

8. Sound select keys

Changes the sound.

9. (standby)

Turns the unit in standby mode (USB charging is still available). To resume, press any buttons.

10. (monitor off)

Turns off the monitor. When the monitor is turned off, touch any part of the display to turn it back on.

11. (EXTRA BASS)

Changes the EXTRA BASS setting.

12. (EQ10/Subwoofer)

Changes the EQ10/Subwoofer setting.

Related Topic

- [General Settings \(General\)](#)
- [Sound Settings \(Sound\)](#)

5-025-746-11(2) Copyright 2021 Sony Corporation

In-Car Receiver
XAV-AX5600/XAV-AX5650

Performing Initial Settings

You need to perform initial settings before operating the unit for the first time, after replacing the car battery, or changing connections.

If the initial settings screen does not appear when you turn on the unit, perform the factory reset to initialize the unit.

- 1 Touch [Language], then set the display language.**
- 2 Touch [Demo] repeatedly to select [OFF] to disable the demonstration mode.**
- 3 Touch [Set Date/Time], then set the date and time.**
XAV-AX5650(EUR): skip to step 5.
- 4 After setting the date and time, touch [OK].**
- 5 To return to the previous display, touch  (back), then touch [OK].**
The startup caution appears.
- 6 Read through the startup caution, then if you accept all conditions, touch [Close].**
The setting is complete.

This setting can be further configured in the setting menu.

Related Topic

- [General Settings \(General\)](#)
- [Sound Settings \(Sound\)](#)
- [Visual Settings \(Visual\)](#)
- [BLUETOOTH Settings \(Bluetooth\)](#)

In-Car Receiver
XAV-AX5600/XAV-AX5650

Preparing a Bluetooth® Device

You can enjoy music or perform handsfree calling depending on the BLUETOOTH compatible device such as smartphones, mobile phones, and audio devices (hereafter “BLUETOOTH device” if not otherwise specified). For details on connecting, refer to the operating instructions supplied with the device. Before connecting the device, turn down the volume of this unit; otherwise, a loud sound may result.

Related Topic





- [Pairing and Connecting with a BLUETOOTH Device](#)
- [Connecting with a Paired BLUETOOTH Device](#)

In-Car Receiver
XAV-AX5600/XAV-AX5650

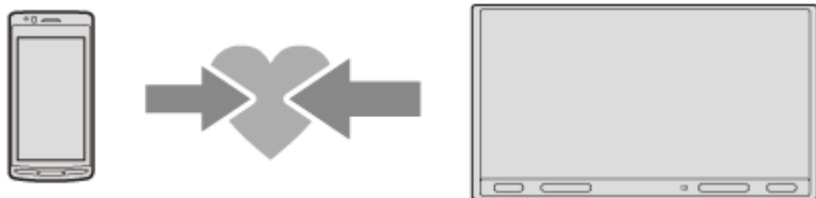
Pairing and Connecting with a BLUETOOTH Device

When connecting a BLUETOOTH device for the first time, mutual registration (called “pairing”) is required. Pairing enables this unit and other devices to recognize each other.



- 1 Place the BLUETOOTH device within 1 m (3 ft) of this unit.**
- 2 Press HOME, then touch [Settings].**
- 3 Touch [Bluetooth].**
- 4 Touch [Bluetooth Connection], then touch [ON].**
The BLUETOOTH signal is turned on and  (BLUETOOTH) lights up on the status bar of the unit.
- 5 Touch [Pairing].**
 (BLUETOOTH) flashes while the unit is in pairing standby mode.
- 6 Perform pairing on the BLUETOOTH device so it detects this unit.**
- 7 Select your model name shown in the display of the BLUETOOTH device.**
Repeat from step 5 if your model name does not appear.
If the connection confirmation display appears, operate the BLUETOOTH device to approve the connection, then touch [OK] on the unit and/or the BLUETOOTH device.
- 8 If passkey* input is required on the BLUETOOTH device, input [0000].**
When pairing is made,  (BLUETOOTH) stays lit.
* Passkey may be called “passcode”, “PIN code”, “PIN number”, “password”, etc., depending on the BLUETOOTH device.
- 9 Select this unit on the BLUETOOTH device to establish the BLUETOOTH connection.**
 (mobile phone) or  (audio) lights up when the connection is made.

Note



- The unit can only be connected with one BLUETOOTH device at a time.
- To disconnect the BLUETOOTH connection, turn the connection off from either the unit or the BLUETOOTH device.
- BLUETOOTH pairing is not possible while Apple CarPlay or Android Auto is running.

In-Car Receiver
XAV-AX5600/XAV-AX5650

Connecting with a Paired BLUETOOTH Device

To use a paired device, connection with this unit is required. Some paired devices will connect automatically.



- 1 Press HOME, then touch [Settings].**
- 2 Touch [Bluetooth].**
- 3 Touch [Bluetooth Connection], then touch [ON].**
Make sure that  (BLUETOOTH) lights up on the status bar of the unit.
- 4 Activate the BLUETOOTH function on the BLUETOOTH device.**
- 5 Operate the BLUETOOTH device to connect to this unit.**
 (mobile phone) or  (audio) lights up on the status bar.

To connect the last-connected device from this unit

When the ignition is turned to on with the BLUETOOTH signal activated, this unit searches for the last-connected BLUETOOTH device, and connection is made automatically.

Note

- While streaming BLUETOOTH audio, you cannot connect from this unit to the mobile phone. Connect from the mobile phone to this unit instead.

To capture your voice during handsfree calling

You need to install the microphone (supplied).

In-Car Receiver
XAV-AX5600/XAV-AX5650

Connecting Rear View Camera

By connecting the optional rear view camera to the CAMERA IN terminal, you can display the picture from the rear view camera.

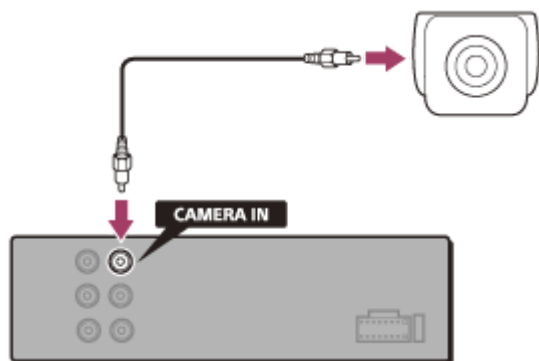

To display the picture from the rear view camera

Press HOME, then touch [Rear Camera].

In-Car Receiver
XAV-AX5600/XAV-AX5650

Listening to the Radio

Press HOME, then touch [Radio].

Reception controls/indications

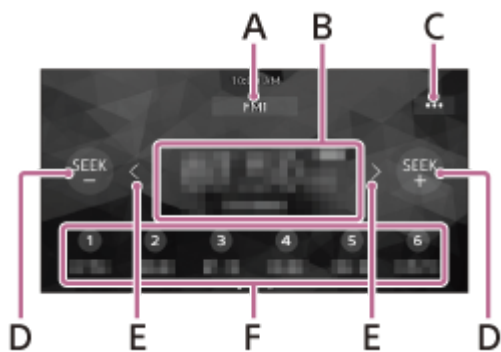

A. Current band

Change the band (FM1, FM2, FM3, AM1 or AM2).

B. Current frequency, program service name*, RDS (Radio Data System) indication*

* Only available during RDS reception.

C. ●●● (radio option)

Open the radio option menu.

D. SEEK - /SEEK +

Tune in automatically.

E. < / > (left/right)

Tune in manually.

Touch and hold to continuously skip frequencies.

F. Preset numbers

Select a preset station. Swipe right/left to show the other preset stations.

Touch and hold to store the current frequency in that preset.

Tuning

1 Select the desired band (FM1, FM2, FM3, AM1 or AM2).

2 Perform tuning.

To tune automatically

Touch SEEK-/SEEK+.

Scanning stops when the unit receives a station.

To tune manually

Touch and hold **</>** (left/right) to locate the approximate frequency, then touch **</>** (left/right) repeatedly to finely adjust to the desired frequency.

To store manually

While receiving the station that you want to store, touch and hold the desired preset number.

To receive stored stations

Select the band, then touch the desired preset number.

Related Topic

- [Listening to the Radio](#)

In-Car Receiver
XAV-AX5600/XAV-AX5650

Using Radio Option Functions

The following functions are available by touching ●●● (option) on the top-right of the screen.



[BTM (Best Tuning Memory)]

Stores stations in order of frequency on the preset numbers. 18 stations for FM and 12 stations for AM can be stored as preset stations.

[AF] (XAV-AX5650(EUR))

Selects [ON] to continuously retune the station to the strongest signal in a network.
(Only available during FM reception.)

[TA] (XAV-AX5650(EUR))

Selects [ON] to receive current traffic information or traffic programs (TP) if available.
(Only available during FM reception.)

[Regional] (XAV-AX5650(EUR))

Selects [ON] to stay with the station you are receiving while the AF function is set to on. If you leave this regional program's reception area, select [OFF]. This function does not work in the UK and some other areas.
(Only available during FM reception.)

[PTY]

Selects a program type from the PTY list to search for a station broadcasting the selected program type.
(Only available during FM reception.)

To receive emergency announcements (XAV-AX5650(EUR))

With the AF or TA function on, emergency announcements will automatically interrupt the currently selected source.

Related Topic

- [Listening to the Radio](#)

In-Car Receiver
XAV-AX5600/XAV-AX5650

Listening to the SiriusXM Radio

Press HOME, then touch [SXM].

To activate your SiriusXM Subscription

Only SiriusXM brings you more of what you love to listen to, all in one place. Get over 140 channels, including commercial-free music plus the best sports, news, talk, comedy and entertainment. Welcome to the world of satellite radio. A SiriusXM Connect Vehicle Tuner and Subscription are required. For more information, visit www.siriusxm.com

After installing your SiriusXM Connect Vehicle Tuner and antenna (aerial), press HOME, then touch [SXM]. You should be able to hear the SiriusXM preview channel on Channel 1. After verifying that you can hear the preview channel, select Channel 0 to find the Radio ID of your radio. In addition, the Radio ID is located on the bottom of the SiriusXM Connect Vehicle Tuner and its packaging. You will need this number to activate your subscription. Write the number down for reference.

Note

- The SiriusXM Radio ID does not include the letters I, O, S or F.

To display the SiriusXM Radio ID

1. Press HOME, then touch [SXM].
2. Touch ●●● (option), then select [Channel Direct Select].
3. Input [000], then touch [OK].

In the USA, you can activate online or by calling SiriusXM Listener Care:

- Visit www.siriusxm.com/activatenow
- Call SiriusXM Listener Care at 1-866-635-2349

For Canadian Subscriptions, please contact:

- Visit www.siriusxm.ca/activate
- Call SiriusXM Customer Care at 1-888-539-7474

As part of the activation process, the SiriusXM satellites will send an activation message to your radio. When your radio detects that the radio has received the activation message, your radio will display: [Subscription Updated Press Enter to Continue]. Once subscribed, you can tune to channels in your subscription plan.

Note

- The activation process usually takes 10 to 15 minutes, but may take up to an hour.
- Your radio will need to be turned on and receiving the SiriusXM signal to receive the activation message.

Tuning Channels for SiriusXM

Reception controls/indications

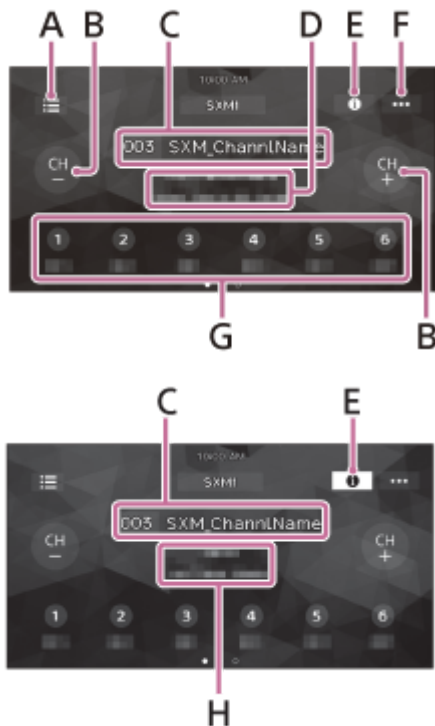

A. ☰ (list)

Open the channel list or category list.

B. CH- (previous channel) /CH+ (next channel)

Select the channel.

C. Channel number, channel name

D. Artist name, song title

E. ⓘ (information)

Switch the channel information.

F. ⋮ (SXM option)

Open the SXM option menu.

G. Preset numbers

Select a preset channel. Swipe right/left to show the other preset channels.
Touch and hold to store the current channel in that preset.

H. Category name, content information

Tuning the Channel by Inputting its Channel Number

- 1 Touch the area with the channel number and channel name on the SiriusXM radio screen.



Alternatively, press ENTER on the remote commander.

- 2 Input the channel number, then touch [OK].

Alternatively, input with the number buttons (0 to 9) and press ENTER on the remote commander.

Related Topic

- [Tuning Channels for SiriusXM](#)

Tuning the Channel from the Channel List or Category List

- 1 Touch  (list) on the SiriusXM radio screen.



The category list appears.

- 2 Touch the desired category.

To tune from the channel list, touch [All Channels].

- 3 Touch the desired channel.

Setting a Parental Control

The parental control feature allows you to limit access to SiriusXM channels with mature content. When enabled, the parental control feature requires you to enter a passcode to tune to the locked channels. Information on setting up the passcode and locking channels can be found below.

- 1 Touch **•••** (option) on the SiriusXM radio screen, then touch **[Parental Control]**.



The passcode input display appears.

- 2 Enter your **4-digit passcode** by touching the number keys, then touch **[OK]**.

The passcode confirmation display appears.

- 3 Enter the **4-digit passcode** again, then touch **[OK]**.

The parental control is applied, and the channels are locked.

To unlock the channels/To lock the channels again

1. Touch **•••** (option), then touch **[Parental Control]**.
The passcode input display appears.
2. Enter your 4-digit passcode by touching the number keys, then touch **[OK]**.

To change the passcode

1. Touch **•••** (option), touch **[Pass Code Change]**, then enter your current passcode.
2. Enter your new passcode, then touch **[OK]**.
The passcode confirmation display appears.
3. Enter your new passcode again, then touch **[OK]**.

In-Car Receiver
XAV-AX5600/XAV-AX5650

Using SXM Option Functions

The following functions are available by touching ●●● (option) on the SiriusXM radio screen.



[Channel Direct Select]

Tunes the desired channel by inputting its channel number directly.

[Parental Control]

Sets the parental lock to on or off.

[Pass Code Change]

Changes the passcode for the Parental Control feature.

In-Car Receiver
XAV-AX5600/XAV-AX5650

Listening to the DAB/DAB+ Radio

Press HOME, then touch [DAB+].

Hint

- Set [Antenna Power] to [ON] (default) or [OFF] depending on the type of DAB antenna (aerial) (not supplied).
- When [DAB+] is selected for the first time after performing the factory reset, the auto tune starts automatically. Allow the auto tune to finish. (If interrupted, the auto tune will start again the next time you select [DAB+].) If no DAB station is stored by the auto tune, tune by touching [Auto Tune] of  (list).

Reception controls/indications

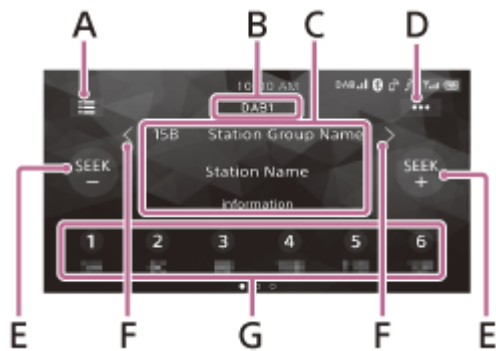

A.  (list)

Open the station list.

B. Current band

Change the band (DAB1, DAB2 or DAB3).

C. Station group name, station name

D. ●●● (DAB Options)

Open the DAB Options menu.

E. SEEK-/SEEK+

Search for stations.

F. < / > (left/right)

Search for station groups.

(Available only when [Seek By] is set to [Station Gp].)

G. Preset numbers

Select a preset station. Swipe right/left to show the other preset stations.

Touch and hold to store the current station in that preset.

Related Topic

- [Using DAB Option Functions](#)

In-Car Receiver
XAV-AX5600/XAV-AX5650

Searching for Station by Station Group

Before operation, set [Seek By] to [Station Gp] for searching by station groups.

1 Touch SEEK+/- to search for a station.

Scanning stops when the unit receives a station. Search until the desired station is received.

To search for a station group

Touch and hold **</>** (left/right) to search for a station group and release when the desired station group is displayed.

To store a station manually

While receiving the station that you want to store, touch and hold the desired preset number.

To receive stored stations

Touch the desired preset number.

Related Topic

- [Using DAB Option Functions](#)

In-Car Receiver
XAV-AX5600/XAV-AX5650

Searching for Station by Station Name

Before operation, set [Seek By] to [A-Z] for searching by station name.

- 1** Touch  (list).
The station list appears.
- 2** Touch the desired station.

To search from playback screen

Touch SEEK+/- to switch to the previous/next station.

To update the station list

Touch  (list), then touch [Auto Tune].

Related Topic

- [Using DAB Option Functions](#)

In-Car Receiver
XAV-AX5600/XAV-AX5650

Using DAB Option Functions

The following functions are available by touching ●●● (option) on the DAB/DAB+ radio screen.



[Seek By]

Sets the station search mode: [A-Z] (Search by station name), [Station Gp] (Search by station group).

[Announce]

Enables DAB announcements with interrupting the currently selected source: [ON], [OFF].
During a DAB announcement, the volume is adjusted to the level set for TA in RDS.

[Soft Link]

Searches for and tunes to the same or similar program automatically when the signal of the current program is too weak to receive: [ON], [OFF].

“Hard Link” follows the same program, and “Soft Link” follows a similar program.

Soft Link	DAB/FM
OFF	Hard Link only
ON	Hard Link/Soft Link

[Information]

Displays the currently selected station group name, station name, PTY type of the station, etc.

[Antenna Power]

Supplies power to the DAB antenna (aerial) input terminal: [ON], [OFF].

Related Topic

- [Using Radio Option Functions](#)

In-Car Receiver
XAV-AX5600/XAV-AX5650

Playing a USB Device

MSC (Mass Storage Class) type USB devices ^{*1} compliant with the USB standard can be used. MTP (Media Transfer Protocol) type USB devices ^{*1} ^{*2} can be used only when connected to the USB port 2.

^{*1} e.g., a USB flash drive, digital media player, Android™ phone

^{*2} Some digital media players or Android phones may require setting to MTP mode.

Note

- For details on the compatibility of your USB device, visit the support site.
- Check the supported file formats for USB playback.

- 1 Turn down the volume on the unit.
- 2 Connect the USB device to the USB port 1 or the USB port 2.
- 3 Press HOME, then touch [USB port 1] or [USB port 2].
Playback starts.

To remove the USB device

Turn the unit off or turn the ignition switch to the ACC off position, then remove the USB device.

Related Topic

- [Supported Formats for USB Playback](#)
- [Customer Support Websites](#)

In-Car Receiver
XAV-AX5600/XAV-AX5650

USB Port 1 and USB Port 2

When connecting the USB devices, select the USB port 1 or the USB port 2 according to the features to be used.

USB port 1

- Apple CarPlay
- Android Auto
- WebLink™
- File system
 - FAT12
 - FAT16
 - FAT32
 - exFAT
- Playable audio format
 - MP3
 - WMA
 - FLAC
 - WAV
 - AAC
- Playable video format
 - MPEG-4
 - WMV
 - MKV
 - Xvid
- USB connection mode
 - MSC

USB port 2

- File system
 - FAT12
 - FAT16
 - FAT32
- Playable audio format
 - MP3
 - WMA
 - FLAC
- USB connection mode
 - MSC
 - MTP

In-Car Receiver
XAV-AX5600/XAV-AX5650

Playing an HDMI™ Device

- 1 Turn off the HDMI device.
- 2 Turn down the volume on the unit.
- 3 Connect the HDMI device to the HDMI terminal on the unit.
- 4 Press HOME, then touch [HDMI].
- 5 Turn on the HDMI device.
Playback starts.

Note

- BLUETOOTH audio is not available when HDMI device is played.
- Do not disconnect the device during playback.
- To connect an Apple device via the HDMI cable, Lightning Digital AV Adapter or USB-C Digital AV Multiport Adapter is required.
- To charge a device when connecting the HDMI cable, connect to the USB port using a multiport adaptor.
- The supplied remote commander works for some of the operations on the unit. (XAV-AX5600(UC))
- For HDMI connection, the supplied remote commander only works for this unit. (XAV-AX5600(UC))
- The image may show up differently on the unit's display compared to the one on the display of the connected HDMI device.
- This unit is compatible with 480p, 576p, and 720p.

In-Car Receiver
XAV-AX5600/XAV-AX5650

Playing a BLUETOOTH Device

You can play contents on a connected device that supports BLUETOOTH A2DP (Advanced Audio Distribution Profile).



- 1 Make a BLUETOOTH connection with the audio device.
- 2 Press HOME, then touch [Bluetooth].
- 3 Operate the audio device to start playback.

Note

- Depending on the audio device, information such as title, track number/time, and playback status may not be displayed on this unit.
- Even if the source is changed on this unit, playback of the audio device does not stop.
- BLUETOOTH pairing is not possible while Apple CarPlay is running.

To match the volume level of the BLUETOOTH device to other sources

You can reduce the volume level differences between this unit and the BLUETOOTH device:
During playback, touch ●●● (option), then set [Input Level] between -6 and +6.

Related Topic

- [Connecting with a Paired BLUETOOTH Device](#)

In-Car Receiver
XAV-AX5600/XAV-AX5650

Repeat Play and Shuffle Play

1 During playback, touch  (repeat) or  (shuffle) repeatedly until the desired play mode appears.



Playback in the selected play mode may take time to start.

Available play modes differ depending on the selected sound source and connected device.

Searching for a File from the List Screen

1 During USB playback, touch (list).

The list screen of the currently played item appears.

When connecting the USB device to the USB port 1, touch  (audio) or  (video) to list up by file type.



2 Touch the desired item.

Playback starts.

Note

- When connecting the USB device to the USB port 2,  (audio) and  (video) do not appear.

In-Car Receiver
XAV-AX5600/XAV-AX5650

Other Settings during Playback

When playing back a video from an HDMI device connected to the HDMI terminal, or from a USB device connected to the USB port 1, further settings are available by touching ●●● (option).

Picture EQ

Adjusts the picture quality according to your taste: [Dynamic], [Standard], [Theater], [Custom]. (Available only when the parking brake is applied.)

Aspect

Selects an aspect ratio for the screen of the unit. (Available only when the parking brake is applied.)

Item	Detail
Normal	Displays a 4:3 picture in its original size, with side bars to fill the 16:9 screen.
Zoom	Displays a 16:9 picture that has been converted into 4:3 letter box format.
Full	Displays a 16:9 picture in its original size.
Captions	Enlarges the picture horizontally, while fitting captions in the screen.

In-Car Receiver
XAV-AX5600/XAV-AX5650

Preparing a Mobile Phone

To use a mobile phone, connect it with this unit.



Note

- The handsfree calling functions are not available when the Apple CarPlay or Android Auto function is activated. In this case, use the handsfree calling functions of the application.

Related Topic

- [Preparing a Bluetooth® Device](#)

In-Car Receiver
XAV-AX5600/XAV-AX5650

Receiving a Call

1 Touch  (call) when a call is received.

The phone call starts.

Note

- The ringtone and talker's voice are output from the front speakers. To select the speakers for handsfree calling, press HOME, then touch [Settings] and select [Phone Call Sound] in [Sound].

To reject/end a call

Touch  (end a call).

Related Topic

- [Preparing a Mobile Phone](#)

Making a Call

1 Press **HOME**, then touch **[Phone]**.

2 Touch one of the call icons on the **BLUETOOTH** phone display.

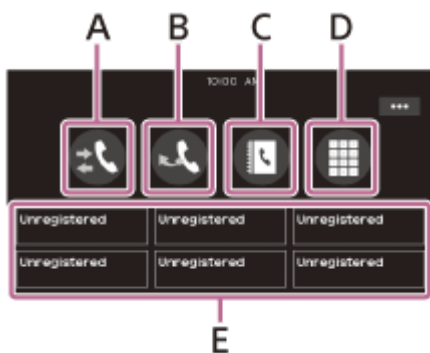

A. (call history)*

Select a contact from the call history list. The unit stores the last 20 calls.

B. (redial)

Make a call automatically to the last contact you made.

C. (contacts)*

Select a contact from the name list/number list. To search for the desired contact in alphabetical order from the name list, touch (alphabetical search).

D. (dialpad)

Enter the phone number.

E. Favorites (favorites)

Select the stored contact.

To store the contact, see "To add phone numbers to Favorites" below.

* The mobile phone needs to support PBAP (Phone Book Access Profile).

3 Touch (call).

The phone call starts.

To add phone numbers to Favorites

You can store up to 6 contacts in the Favorites.

1. On the phone screen, touch (contacts) and select a phone number you want to store in the Favorites.
The confirmation display appears.
2. Touch **[Add to Favorites]**.
3. Touch the desired preset in the Favorites to store the phone number.
The contact is stored in the Favorites.

Related Topic

- [Preparing a Mobile Phone](#)



In-Car Receiver
XAV-AX5600/XAV-AX5650

Available Operations during a Call

To adjust the ringtone volume

Press VOL (volume) +/- while receiving a call.

To adjust the talker's voice volume

Press VOL (volume) +/- during a call.

To adjust the volume for the other party (Mic gain adjustment)

During a handsfree call, touch ●●● (option), then set [MIC Gain] to [High], [Middle], or [Low].

To reduce echo and noise (Echo/noise canceler mode)

During a call, touch ●●● (option), then set [Speech Quality] to [Mode 1] or [Mode 2].

To switch between handsfree mode and handheld mode

During a call, touch  ↔  (speaker/phone) to switch the phone call audio between the unit and mobile phone.

Note

- Depending on the mobile phone, this operation may not be available.

To answer an incoming call automatically

Touch ●●● (option), then set [Auto Answer] to [ON].

In-Car Receiver
XAV-AX5600/XAV-AX5650

Apple CarPlay

Apple CarPlay lets you use your iPhone in the car in a way that allows you to stay focused on the road.
(Available only when your iPhone is connected to the USB port 1.)

Notes on using Apple CarPlay

- Check the Apple CarPlay website for supported iOS versions. Update to the latest iOS version before use.
- For details about Apple CarPlay, refer to the manual supplied with your iPhone, or visit the Apple CarPlay website.
- Since the GPS on your iPhone is used, place your iPhone where it can easily receive a GPS signal.

1 Connect your iPhone to the USB port 1.

To connect an iPhone, use a USB connection cable for iPhone (not supplied).

2 Press HOME, then touch the Apple CarPlay icon.

Your iPhone's display appears on the display of the unit. Touch and control the applications.

Use of the Apple CarPlay logo means that a vehicle user interface meets Apple performance standards. Apple is not responsible for the operation of this vehicle or its compliance with safety and regulatory standards. Please note that the use of this product with iPhone may affect wireless performance.

In-Car Receiver
XAV-AX5600/XAV-AX5650

Android Auto™

Android Auto extends the Android platform into the car in a way that's purpose-built for driving.
(Available only when your Android phone is connected to the USB port 1.)

Notes on using Android Auto

- Check the Android Auto website for supported OS versions. Update to the latest OS version before use.
- Your Android phone needs to support Android Auto.
- Download the Android Auto app on Google Play.
- For details about Android Auto, refer to the manual supplied with your Android phone, or visit the Android Auto website.
- Since the GPS on your Android phone is used, place your Android phone where it can easily receive a GPS signal.
- Android Auto may not be available in your country or region.

1 Connect your Android phone to the USB port 1.

To connect an Android phone, use an appropriate connection cable (not supplied).

2 Press HOME, then touch the Android Auto icon.

The Android Auto interface will be displayed full-screen on the display of the unit. Touch and control the applications.

In-Car Receiver
XAV-AX5600/XAV-AX5650

WebLink™

The “WebLink Host” app allows you to enjoy the “WebLink Apps” such as a video or music player on the connected iPhone/Android phone.

(Available only when your iPhone/Android phone is connected to the USB port 1.)

Notes on using WebLink™

- Check the WebLink™ website for supported OS versions. Update to the latest OS version before use.
- For details on compatible models, refer to the compatibility list on the following site:
<http://abaltatech.com/WL>
- Download the “WebLink Host” app available on Google Play for your Android phone, and available on the App Store for your iPhone.
- A network connection may be required when configuring settings, such as during the initial connection setup. Make sure that a network connection is available on your iPhone/Android phone.
- When using the Cast function, settings on your iPhone/Android phone may be required.
- For details about the “WebLink Apps”, visit the website for the “WebLink Apps”.
- The WebLink™ function and/or a certain “WebLink Apps” may not be available in your country or region.
- When using the Cast function and connecting the iPhone, the display direction is the same as the display of the iPhone.

1 Connect your iPhone/Android phone with main unit via BLUETOOTH.

2 Connect your iPhone/Android phone to the USB port 1.

To connect an iPhone, use a USB connection cable for iPhone (not supplied).

To connect an Android phone, use an appropriate connection cable (not supplied).

3 Press HOME, then touch the WebLink™ icon.

The WebLink™ display appears on the display of the unit. Touch and control the applications.

Hint

- You can switch the app between Apple CarPlay/Android Auto and WebLink™ if these apps are installed on your iPhone/Android phone.

In-Car Receiver
XAV-AX5600/XAV-AX5650

Using Gesture Command

You can perform frequently-used operations by swiping your finger on the reception/playback display.

Note

- The gesture commands explained below are not available on the screens of Apple CarPlay, Android Auto and WebLink™.

Swipe left to right

Radio reception:

seek forward stations. (The same as pressing and holding  (next).)

SiriusXM reception (XAV-AX5600(UC)):

tune the next channel (channel +).

Video/audio playback:

skip forward a file/track. (The same as  (next).)

Swipe right to left

Radio reception:

seek backward stations. (The same as pressing and holding  (previous).)

SiriusXM reception (XAV-AX5600(UC)):

tune the previous channel (channel -).

Video/audio playback:

skip backward a file/track. (The same as  (previous).)

Swipe upwards

Radio reception:

receive stored stations (go forward).

SiriusXM reception (XAV-AX5600(UC)):

tune the next preset (preset +).

Swipe downwards

Radio reception:

receive stored stations (go backward).

SiriusXM reception (XAV-AX5600(UC)):

tune the previous preset (preset -).

In-Car Receiver
XAV-AX5600/XAV-AX5650

Basic Setting Operation

You can set items in the following setup categories: General Settings (General), Sound Settings (Sound), Visual Settings (Visual), BLUETOOTH Settings (Bluetooth).

- 1 Press HOME, then touch [Settings].**
- 2 Touch one of the setup category.**
The items that can be set differ depending on the source and settings.
- 3 Move the scrollbar up and down to select the desired item.**

To return to the previous display

Touch  (back).

To switch to the playback screen

Touch  (return to the playback screen).

Related Topic

- [General Settings \(General\)](#)
- [Sound Settings \(Sound\)](#)
- [Visual Settings \(Visual\)](#)
- [BLUETOOTH Settings \(Bluetooth\)](#)
- [Canceling the Demonstration Mode](#)

In-Car Receiver
XAV-AX5600/XAV-AX5650

General Settings (General)

Language

Selects the display language: [English], [Español], [Français], [Deutsch], [Italiano], [Português], [Русский], [ไทย], [العربية], [简体中文], [繁體中文], [한국어], [Indonesia].

Demo

Activates the demonstration: [OFF], [ON].

Date/Time

Item	Detail
Set Date/Time	Sets the date and clock time: [Auto(RDS)], [Manual]. (XAV-AX5650(EUR)): [Auto(DAB)], [Manual].
Date Format	Selects the format: [DD-MM-YYYY], [MM-DD-YYYY], [YYYY-MM-DD].
Time Format	Selects the format: [12-hour], [24-hour].

Beep

Activates the operation sound: [OFF], [ON].

Rear View Camera

Selects the image from the rear view camera: [OFF], [Normal], [Reverse] (mirror image).
[Guide Line Adjust] adjusts the guide on the picture from the rear view camera.
Touch the near side **A** or far side **B** (red portions) of the guide to adjust.

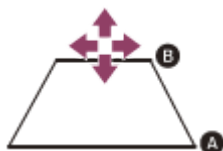



Touch </ ^ / > / v (left/up/right/down) to adjust the guide position, and touch → ← (inward) or ← → (outward) to adjust the guide width.

Steering Control

Selects the input mode for the connected remote control. To prevent a malfunction, be sure to match the input mode with the connected remote control before use.

Item	Detail
------	--------

Item	Detail
Custom	Input mode for the steering wheel remote control (follow the procedures of  (register/setup) to register functions on the connected remote control).
Preset	Input mode for the wired remote control excluding the steering wheel remote control.
 (register/setup)	<p>The steering button screen appears.</p> <ol style="list-style-type: none"> ① Press and hold the button you want to assign to the steering wheel. The button on the screen lights up (standby). ② Press and hold the button on the steering wheel you want to assign the function to. The button on the screen will change the color (highlighted or encircled by an orange line). ③ To register other functions, repeat steps ① and ②. <p>(Available only when [Steering Control] is set to [Custom].)</p>

Note

- While making settings, the connected remote control cannot be used even though some functions have already been registered. Use the buttons on the unit.
- If an error occurs while registering, all the registered information is cleared. Restart registration from the beginning.
- This function may not be available on some vehicles. For details on the compatibility of your vehicle, visit the support site.

Driving Position

Selects the driving position to optimize usability of Apple CarPlay and Android Auto: [Left Side], [Right Side].

SXM Reset (XAV-AX5600(UC))

Initializes the SiriusXM Connect Vehicle Tuner settings (preset channels/parental lock): [Reset], [Cancel].

Factory Reset

Initializes all the settings to the factory settings.

Firmware Version

Updates and confirms the firmware version.

Open Source Licenses

Displays the software licenses.

Related Topic

- [Basic Setting Operation](#)
- [Customer Support Websites](#)

In-Car Receiver
XAV-AX5600/XAV-AX5650

Sound Settings (Sound)

EXTRA BASS

Reinforces bass sound in synchronization with the volume level: [OFF], [1], [2].

EQ10/Subwoofer

Selects an equalizer curve and adjusts the subwoofer level.
(Available when any source is selected.)

Item	Detail
EQ10	Selects the equalizer curve: [OFF], [R&B], [Rock], [Pop], [Hip-Hop], [Dance], [EDM], [Jazz], [Soul], [Country], [Custom] [Custom] adjusts the equalizer curve: -6 to +6.
Subwoofer	Adjusts the volume level of the subwoofer: [OFF], -10 to +10.

Balance/Fader

Adjusts the balance/fader level.

Item	Detail
Balance	Adjusts the sound balance between the left and right speakers: [L15] to [R15].
Fader	Adjusts the sound balance between the front and rear speakers: [Front 15] to [Rear 15].

Crossover

Adjusts the cut-off frequency and subwoofer phase.

Item	Detail
High Pass Filter	Selects the cut-off frequency of the front/rear speakers: [OFF], [50Hz], [60Hz], [80Hz], [100Hz], [120Hz].
Low Pass Filter	Selects the cut-off frequency of the subwoofer: [OFF], [50Hz], [60Hz], [80Hz], [100Hz], [120Hz].
Subwoofer Phase	Selects the subwoofer phase: [Normal], [Reverse].

DSO (Dynamic Stage Organizer)

Enhances audio output: [OFF], [Low], [Middle], [High].

Volume Settings

Adjusts the volume level of each source.

Item	Detail
Media	Adjusts the volume of media: 0 to 50.
Radio Announcements (XAV-AX5650(EUR))	Adjusts the volume of radio announcements: 0 to 50.
Phone Call	Adjusts the volume of phone calls: 0 to 50.
Ring Tone	Adjusts the volume of the ring tone: 0 to 50.
Voice Recognition	Adjusts the volume of voice recognition: 0 to 50.
Navigation Guidance	Adjusts the volume of navigation guidance: 0 to 50.

Note

- When adjusting the volume settings, park your car in a safe place as it may be too loud to hear the surrounding sounds.

Phone Call Sound

Selects the speakers for handsfree calling: [Front], [Rear], [All].

Guidance during Call

Activates the notices of Apple CarPlay through navigation guidance or alert sounds during a phone call: [ON], [OFF].
(Not available when Android Auto is connected.)

Related Topic

- [Basic Setting Operation](#)

In-Car Receiver
XAV-AX5600/XAV-AX5650

Visual Settings (Visual)

Wallpaper

Changes the wallpaper by touching the desired color or sets your favorite photo data in a MSC (Mass Storage Class) type USB device as a wallpaper.

(Available only when photo data are JPEG files of 6 MB or less.)

To set a photo data

When connecting the USB device to the USB port 1, [You can import a photo from a USB device] appears on the screen. Touch [Import], and select your favorite photo.

Dimmer for Monitor & Illum.

Dims the display and the button illumination: [OFF], [Auto], [ON].

([Auto] is available only when the illumination control lead is connected and works when the head light is turned on.)

 (register/setup) adjusts the brightness level when the dimmer is activated: -5 to +5.

Illum. Level on Monitor OFF

Dims the button illumination when the monitor is turned off: [OFF], [1], [2], [3], [4].

Related Topic

- [Basic Setting Operation](#)

In-Car Receiver
XAV-AX5600/XAV-AX5650

BLUETOOTH Settings (Bluetooth)

Bluetooth Connection

Activates the BLUETOOTH signal: [OFF], [ON], [Pairing] (enters into pairing standby mode).

Bluetooth Device Info

Displays the information of the BLUETOOTH device connected to the unit.
(Available only when [Bluetooth Connection] is set to [ON] and a BLUETOOTH device is connected to the unit.)

Bluetooth Reset

Initializes all BLUETOOTH-related settings such as pairing information, call history, history of connected BLUETOOTH devices, etc.

Related Topic

- [Basic Setting Operation](#)

In-Car Receiver
XAV-AX5600/XAV-AX5650

Canceling the Demonstration Mode

- 1 Press **HOME**, then touch **[Settings]**.
 - 2 Touch **[General]**, then touch **[Demo]** to set to **[OFF]**.
 - 3 To exit the setup menu, touch  (back) twice.
-
-

Related Topic

- [General Settings \(General\)](#)

In-Car Receiver
XAV-AX5600/XAV-AX5650

Updating the Firmware

To update the firmware, visit the support site, then follow the online instructions.

Note

- During the update, do not remove the USB device.
- You will need to insert the USB device to USB port 1, then switch to USB port 2 following the on-screen guidance.

Related Topic

- [Customer Support Websites](#)

In-Car Receiver
XAV-AX5600/XAV-AX5650

Precautions

- Power antenna (aerial) extends automatically.
- When you transfer ownership or dispose of your car with the unit installed, initialize all the settings to the factory settings by performing the factory reset.
- Do not splash liquid onto the unit.

Notes on safety

- Comply with your local traffic rules, laws, and regulations.
- While driving
 - Do not watch or operate the unit, as it may lead to distraction and cause an accident. Park your car in a safe place to watch or operate the unit.
 - Do not use the setup feature or any other function which could divert your attention from the road.
 - When backing up your car, be sure to look back and watch the surroundings carefully for your safety even if the rear view camera is connected. Do not depend on the rear view camera exclusively.
- While operating
 - Do not insert your hands, fingers, or foreign objects into the unit as it may cause injury or damage to the unit.
 - Keep small articles out of the reach of children.
 - Be sure to fasten seatbelts to avoid injury in the event of sudden movement of the car.

Preventing an accident

Pictures appear only after you park the car and set the parking brake. If the car starts moving during video playback, the following caution is displayed and you cannot watch the video.

[Video blocked for your safety.]

Do not operate the unit or watch the monitor while driving.

Notes on LCD panel

- Do not get the LCD panel wet or expose it to liquids. This may cause a malfunction.



- Do not press down hard on the LCD panel as doing so can distort the picture or cause a malfunction (i.e., the picture may become unclear or the LCD panel may be damaged).
- Do not touch the panel with objects other than with your finger as it may damage or break the LCD panel.
- Clean the LCD panel with a dry soft cloth. Do not use solvents such as benzene, thinner, commercially available cleaners, or antistatic spray.
- Do not use the unit outside the temperature range 0 °C to 40 °C (32 °F to 104 °F).
- If your car was parked in a cold or hot place, the picture may not be clear. However, the monitor is not damaged and the picture will become clear after the temperature in your car becomes normal.

- Some stationary blue, red, or green dots may appear on the monitor. These are called “bright spots” and can happen with any LCD. The LCD panel is precision-manufactured with more than 99.99% of its segments functional. However, it is possible that a small percentage (typically 0.01%) of the segments may not light up properly. This will not, however, interfere with your viewing.

Notes on the touch screen

- This unit uses a capacitive touch screen. Touch the screen directly with your fingertip.
- Multi-touch operation is not supported on this unit.
- Do not touch the screen with sharp objects such as a needle, pen, or fingernail. Operation with a stylus is not supported on this unit.
- Touching the screen with a gloved finger may cause the unit to operate incorrectly or not respond.
- Do not let any objects contact the touch screen. If the screen is touched by an object other than your fingertip, the unit may not respond correctly.
- Since glass material is used for the screen, do not subject the unit to strong shock. If cracking or chipping occurs on the screen, do not touch the damaged part as it may cause injury.
- Keep other electrical devices away from the touch screen. They may cause the touch screen to malfunction.
- If there are water droplets on the touch screen, or if you touch the screen with wet fingertips, the touch screen may not react correctly.

If you have any questions or problems concerning your unit that are not covered in this Help Guide, consult your nearest Sony dealer.

Related Topic

- [General Settings \(General\)](#)

In-Car Receiver
XAV-AX5600/XAV-AX5650

Supported Formats for USB Playback

USB port 1:

- WMA (.wma)^{*1 *2}
Bit rate: 48 kbps – 192 kbps (Supports variable bit rate (VBR))^{*3}
Sampling frequency^{*4} : 44.1 kHz
- MP3 (.mp3)^{*1 *2}
Bit rate: 48 kbps – 320 kbps (Supports variable bit rate (VBR))^{*3}
Sampling frequency^{*4} : 32 kHz, 44.1 kHz, 48 kHz
- AAC (.m4a)^{*1 *2}
Bit rate: 40 kbps – 320 kbps (Supports variable bit rate (VBR))^{*3}
Sampling frequency^{*4} : 8 kHz – 48 kHz
Bit per sample (Quantization bit): 16 bits
- FLAC (.flac)^{*1 *6}
Sampling frequency^{*4} : 8 kHz – 48 kHz
Bit per sample (Quantization bit): 16 bits
- WAV (.wav)^{*1}
Sampling frequency^{*4} : 8 kHz – 48 kHz
Bit per sample (Quantization bit): 16 bits, 24 bits
- Xvid (.avi)
Video codec: MPEG-4 Advanced Simple Profile
Audio codec: MP3 (MPEG-1 Layer3)
Bit rate: Max. 4 Mbps
Frame rate: Max. 30 fps (30p/60i)
Resolution: Max. 1280 × 720^{*5}
- MPEG-4 (.mp4)
Video codec: MPEG-4 Advanced Simple Profile, AVC Baseline Profile
Audio codec: AAC
Bit rate: Max. 4 Mbps
Frame rate: Max. 30 fps (30p/60i)
Resolution: Max. 1280 × 720^{*5}
- WMV (.wmv, .avi)^{*1}
Video codec: WMV3, WVC1
Audio codec: MP3, WMA
Bit rate: Max. 6 Mbps
Frame rate: Max. 30 fps
Resolution: Max. 720 × 480^{*5}
- MKV (.mkv)
Video codec: MPEG-4 Advanced Simple Profile, AVC Baseline Profile
Audio codec: MP3, AAC
Bit rate: Max. 5 Mbps
Frame rate: Max. 30 fps
Resolution: Max. 1280 × 720^{*5}

USB port 2:

- WMA (.wma)^{*1 *2}
Bit rate: 48 kbps – 192 kbps (Supports variable bit rate (VBR))^{*3}

Sampling frequency*4 : 44.1 kHz

- MP3 (.mp3)*1 *2

Bit rate: 48 kbps – 320 kbps (Supports variable bit rate (VBR))*3

Sampling frequency*4 : 32 kHz, 44.1 kHz, 48 kHz

- FLAC (.flac)*1

Sampling frequency*4 : 8 kHz – 48 kHz

Bit per sample (Quantization bit): 8 bits, 16 bits, 24 bits

*1 Copyright-protected files and multi-channel audio files cannot be played back.

*2 DRM (Digital Rights Management) files cannot be played back.

*3 Non-standard bit rates or non-guaranteed bit rates are included depending on the sampling frequency.

*4 Sampling frequency may not correspond to all encoders.

*5 These numbers indicate the maximum resolution of playable video and do not indicate the player's display resolution. The display resolution is 800 × 480.

*6 Displaying the tag information is not supported.

Note

- Some files may not be played back even though their file formats are supported by the unit.

In-Car Receiver
XAV-AX5600/XAV-AX5650

About iPhone

- **Compatible iPhone models:**

iPhone SE (2nd generation), iPhone 11 Pro Max, iPhone 11 Pro, iPhone 11, iPhone XS Max, iPhone XS, iPhone XR, iPhone X, iPhone 8 Plus, iPhone 8, iPhone 7 Plus, iPhone 7, iPhone SE, iPhone 6s Plus, iPhone 6s, iPhone 6 Plus, iPhone 6, iPhone 5s

- Use of the Made for Apple badge means that an accessory has been designed to connect specifically to the Apple product(s) identified in the badge, and has been certified by the developer to meet Apple performance standards. Apple is not responsible for the operation of this device or its compliance with safety and regulatory standards. Please note that the use of this accessory with an Apple product may affect wireless performance.

In-Car Receiver
XAV-AX5600/XAV-AX5650

Notice on License

This product contains software that Sony uses under a licensing agreement with the owner of its copyright. We are obligated to announce the contents of the agreement to customers under requirement by the owner of copyright for the software. For details on software licenses, select [Settings] → [General] → [Open Source Licenses].

If you have any questions or problems concerning your unit that are not covered in this Help Guide, consult your nearest Sony dealer.

Related Topic

- [General Settings \(General\)](#)

In-Car Receiver
XAV-AX5600/XAV-AX5650

Maintenance

Replacing the lithium battery (CR2025) of the remote commander (XAV-AX5600(UC))

When the battery becomes weak, the range of the remote commander becomes shorter.

CAUTION

Danger of explosion if battery is incorrectly replaced. Replace only with the same or equivalent type.

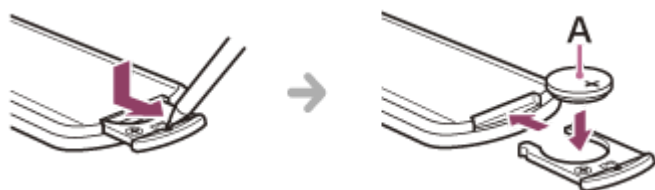

A: Lithium battery (CR2025) + side up

Note

- Keep the lithium battery out of the reach of children. Should the battery be swallowed, immediately consult a doctor.

In-Car Receiver
XAV-AX5600/XAV-AX5650

Specifications

FOR THE CUSTOMERS IN THE USA. NOT APPLICABLE IN CANADA, INCLUDING IN THE PROVINCE OF QUEBEC.

POUR LES CLIENTS AUX ÉTATS-UNIS. NON APPLICABLE AU CANADA, Y COMPRIS LA PROVINCE DE QUÉBEC.

AUDIO POWER SPECIFICATIONS



CTA2006 Standard

Power Output: 20 Watts RMS × 4 at 4 Ohms < 1% THD+N

SN Ratio: 80 dBA (reference: 1 Watt into 4 Ohms)

Monitor section

Display type	Wide LCD color monitor
Dimensions	17.6 cm/ 6.95 in
System	TFT active matrix
Number of pixels	1,152,000 pixels (800 × 3 (RGB) × 480)
Color system	PAL/NTSC automatic select for CAMERA IN terminal

Radio section

XAV-AX5600(UC):

FM

Tuning range	87.5 MHz – 107.9 MHz
Usable sensitivity	7 dBf
Signal-to-noise ratio	70 dB (mono)
Separation at 1 kHz	45 dB

AM

Tuning range	530 kHz – 1,710 kHz
Sensitivity	32 μV

XAV-AX5650(EUR):

DAB/DAB+

Tuning range	174.928 MHz – 239.200 MHz
Antenna (aerial) terminal	External antenna (aerial) connector

FM

Tuning range	87.5 MHz – 108.0 MHz
Usable sensitivity	7 dBf
Signal-to-noise ratio	70 dB (mono)
Separation at 1 kHz	45 dB

AM

Tuning range	531 kHz – 1,602 kHz
Sensitivity	32 μ V

USB player section

Interface	USB port 1 (Hi-speed) USB port 2 (Full-speed)
Maximum current	USB port 1: 1.5 A USB port 2: 500 mA

HDMI section*

Input format	480p, 576p, 720p
--------------	------------------

* HDMI output is not available.

Wireless communication

Communication System	BLUETOOTH Standard version 3.0
Output	BLUETOOTH Standard Power Class 2 (Max. Conducted +1 dBm)
Maximum communication range* ¹	Line of sight approx. 10 m (33 ft)
Frequency band	2.4 GHz band (2.4000 GHz – 2.4835 GHz)
Modulation method	FHSS
Compatible BLUETOOTH Profiles* ²	A2DP (Advanced Audio Distribution Profile) 1.3 AVRCP (Audio Video Remote Control Profile) 1.3

	HFP (Handsfree Profile) 1.6 PBAP (Phone Book Access Profile) 1.1
Corresponding codec	SBC, AAC

*1 The actual range will vary depending on factors such as obstacles between devices, magnetic fields around a microwave oven, static electricity, reception sensitivity, antenna (aerial) performance, operating system, software application, etc.

*2 BLUETOOTH standard profiles indicate the purpose of BLUETOOTH communication between devices.

Power amplifier section

Outputs	Speaker outputs
Speaker impedance	4 Ω – 8 Ω
Maximum power output	55 W \times 4 (at 4 Ω)

General

Power requirements	12 V DC car battery (negative ground (earth))
Rated current consumption	10 A
Dimensions (maximum)	Approx. 178 mm \times 100 mm \times 139 mm (7 1/8 in \times 4 in \times 5 1/2 in) (w/h/d)
Mounting dimensions	Approx. 182 mm \times 111 mm \times 120 mm (7 1/4 in \times 4 3/8 in \times 4 3/4 in) (w/h/d)
Mass	Approx. 1.0 kg (2 lb 4 oz)
Package contents	Main unit (1) Parts for installation and connections (1 set) Remote commander (1): RM-X170 (XAV-AX5600(UC))
Optional accessories/equipment	SiriusXM Connect Vehicle Tuner: SXV100, SXV200, SXV300 (XAV-AX5600(UC))

Ask the dealer for detailed information.

Design and specifications are subject to change without notice.

In-Car Receiver
XAV-AX5600/XAV-AX5650

Copyrights



SiriusXM-Ready® allows you to Listen to ad-free music, plus all the sports, talk, comedy, news coverage, all in one place. (SiriusXM Connect Tuner and subscription required. Sold separately.) For more information, visit www.siriusxm.com.

Sirius, XM and all related marks and logos are trademarks of Sirius XM Radio Inc. All rights reserved.

The Bluetooth® word mark and logos are registered trademarks owned by Bluetooth SIG, Inc. and any use of such marks by Sony Corporation is under license. Other trademarks and trade names are those of their respective owners.

Windows Media is either a registered trademark or trademark of Microsoft Corporation in the United States and/or other countries.

This product is protected by certain intellectual property rights of Microsoft Corporation. Use or distribution of such technology outside of this product is prohibited without a license from Microsoft or an authorized Microsoft subsidiary.

Apple, iPhone, and Lightning are trademarks of Apple Inc., registered in the U.S. and other countries. Apple CarPlay is a trademark of Apple Inc.

IOS is a trademark or registered trademark of Cisco in the U.S. and other countries and is used under license.

Android, Android Auto, Google and Google Play are trademarks of Google LLC.

WebLink is a registered trademark of Abalta Technologies, Inc. in the U.S. and a trademark in the other countries.

The terms HDMI, HDMI High-Definition Multimedia Interface, and the HDMI Logo are trademarks or registered trademarks of HDMI Licensing Administrator, Inc.

THIS PRODUCT IS LICENSED UNDER THE MPEG-4 VISUAL PATENT PORTFOLIO LICENSE FOR THE PERSONAL AND NON-COMMERCIAL USE OF A CONSUMER FOR DECODING VIDEO IN COMPLIANCE WITH THE MPEG-4 VISUAL STANDARD ("MPEG-4 VIDEO") THAT WAS ENCODED BY A CONSUMER ENGAGED IN A PERSONAL AND NONCOMMERCIAL ACTIVITY AND/OR WAS OBTAINED FROM A VIDEO PROVIDER LICENSED BY MPEG LA TO PROVIDE MPEG-4 VIDEO.

NO LICENSE IS GRANTED OR SHALL BE IMPLIED FOR ANY OTHER USE.

ADDITIONAL INFORMATION INCLUDING THAT RELATING TO PROMOTIONAL, INTERNAL AND COMMERCIAL USES AND LICENSING MAY BE OBTAINED FROM MPEG LA, LLC. SEE

[HTTP://WWW.MPEGLA.COM](http://WWW.MPEGLA.COM)

THIS PRODUCT IS LICENSED UNDER THE AVC PATENT PORTFOLIO LICENSE FOR THE PERSONAL AND NON-COMMERCIAL USE OF A CONSUMER TO

(i) ENCODE VIDEO IN COMPLIANCE WITH THE AVC STANDARD ("AVC VIDEO") AND/OR

(ii) DECODE AVC VIDEO THAT WAS ENCODED BY A CONSUMER ENGAGED IN A PERSONAL AND NON-

COMMERCIAL ACTIVITY AND/OR WAS OBTAINED FROM A VIDEO PROVIDER LICENSED TO PROVIDE AVC

VIDEO. NO LICENSE IS GRANTED OR SHALL BE IMPLIED FOR ANY OTHER USE. ADDITIONAL INFORMATION

MAY BE OBTAINED FROM MPEG LA, L.L.C. SEE

[HTTP://WWW.MPEGLA.COM](http://WWW.MPEGLA.COM)

THIS PRODUCT IS LICENSED UNDER THE AVC PATENT PORTFOLIO LICENSE AND VC-1 PATENT PORTFOLIO LICENSE FOR THE PERSONAL AND NON-COMMERCIAL USE OF A CONSUMER TO DECODE VIDEO IN COMPLIANCE WITH THE AVC STANDARD ("AVC VIDEO") AND/OR THE VC-1 STANDARD ("VC-1 VIDEO") THAT

WAS ENCODED BY A CONSUMER ENGAGED IN A PERSONAL AND NONCOMMERCIAL ACTIVITY AND/OR WAS OBTAINED FROM A VIDEO PROVIDER LICENSED TO PROVIDE AVC VIDEO AND/OR VC-1 VIDEO. NO LICENSE IS GRANTED OR SHALL BE IMPLIED FOR ANY OTHER USE. ADDITIONAL INFORMATION MAY BE OBTAINED FROM MPEG LA, L.L.C. SEE [HTTP://WWW.MPEGLA.COM](http://www.mpegla.com)

All other trademarks are trademarks of their respective owners.

5-025-746-11(2) Copyright 2021 Sony Corporation

In-Car Receiver
XAV-AX5600/XAV-AX5650

Troubleshooting

Do the following before you request a repair service.

- Read the relevant instruction and troubleshooting topics in this Help Guide.
- Issues may be resolved by updating the software. When you install the “Support by Sony” app on your smartphone, you can get software update information conveniently.
- Visit our customer support home page.

If none of the above works, consult your nearest Sony dealer.

Related Topic

- [Customer Support Websites](#)
- [About the “Support by Sony” App](#)

In-Car Receiver
XAV-AX5600/XAV-AX5650

There is no beep sound.

- An optional power amplifier is connected and you are not using the built-in amplifier.

In-Car Receiver
XAV-AX5600/XAV-AX5650

The fuse has blown. / The unit makes noise when the position of the ignition is switched.

- The power supply leads are not matched correctly with the car's accessory power connector.

In-Car Receiver
XAV-AX5600/XAV-AX5650

The display disappears from/does not appear on the monitor.

- The monitor off function is activated.
 - Touch anywhere on the display to turn the display back on.
-

Related Topic

- [Main Unit and Remote Commander](#)
- [Screen Displays](#)

In-Car Receiver
XAV-AX5600/XAV-AX5650

Menu items cannot be selected.

- Unavailable menu items are displayed in gray.

In-Car Receiver
XAV-AX5600/XAV-AX5650

The USB functions do not work properly.

- Do not use a USB extension cable as it may cause deterioration of signal quality.
 - Use a shorter USB cable when connecting the USB device, or replace the USB cable with a new one.

In-Car Receiver
XAV-AX5600/XAV-AX5650

The unit cannot be operated.

- Press and hold HOME for more than 10 seconds to restart the unit. For your safety, do not restart the unit while you are driving.

In-Car Receiver
XAV-AX5600/XAV-AX5650

The clock set automatically is not accurate.

- The clock data on radio waves is not accurate.
 - Press HOME, select [Settings] → [General] → [Date/Time] → [Set Date/Time], then set to [Manual]. After that, touch  (register/setup) and adjust the clock manually.
-

Related Topic

- [General Settings \(General\)](#)

In-Car Receiver
XAV-AX5600/XAV-AX5650

The touch screen does not react to your touch correctly.

- Touch one part of the touch screen at a time. If two or more parts are touched simultaneously, the touch screen will not react correctly.
- Touch the pressure sensitive screen firmly.
- The touch screen does not react when touching with a wet fingertip or when water droplets are on the touch screen.
 - Dry your wet fingertips well, or fully wipe water droplets off of the touch screen.

In-Car Receiver
XAV-AX5600/XAV-AX5650

Multi-touch is not recognized.

- Multi-touch operation is not supported on this unit.

In-Car Receiver
XAV-AX5600/XAV-AX5650

The radio reception is poor. / Static noise occurs.

- Connect the antenna (aerial) firmly.

In-Car Receiver
XAV-AX5600/XAV-AX5650

PTY displays [PTY not found].

- The current station is not an RDS station, or the radio reception is poor.

In-Car Receiver
XAV-AX5600/XAV-AX5650

Seek starts after a few seconds of listening. (XAV-AX5650(EUR))

- The station is non-TP or has a weak signal.
 - Deactivate TA.
-
-

Related Topic

- [Using Radio Option Functions](#)

In-Car Receiver
XAV-AX5600/XAV-AX5650

There are no traffic announcements. (XAV-AX5650(EUR))

- Activate TA.
 - The station does not broadcast any traffic announcements despite being TP.
 - Tune into another station.
-
-

Related Topic

- [Using Radio Option Functions](#)

In-Car Receiver
XAV-AX5600/XAV-AX5650

Stations cannot be received.

- See [No Station] for details when the DAB signal cannot be received.
-

Related Topic

- [DAB radio \(XAV-AX5650\(EUR\)\)](#)

In-Car Receiver
XAV-AX5600/XAV-AX5650

No traffic announcements.

- Disable DAB announcements.
 - Traffic announcements (TA) are not available while DAB announcements are enabled.
-
-

Related Topic

- [Using DAB Option Functions](#)

In-Car Receiver
XAV-AX5600/XAV-AX5650

There is no picture or picture noise occurs.

- A connection has not been made correctly.
 - Check the connection between this unit and other equipment, and set the input selector of the equipment to the source corresponding to this unit.
- Installation is not correct.
 - Install the unit at an angle of less than 30° in a sturdy part of the car.
- The parking lead (light green) is not connected to the parking brake switch lead, or the parking brake is not applied.
 - Check that the parking lead is firmly connected to the parking brake switch lead, then apply the parking brake.

In-Car Receiver
XAV-AX5600/XAV-AX5650

The picture does not fit in the screen.

- The aspect ratio is fixed on the playback source.

In-Car Receiver
XAV-AX5600/XAV-AX5650

There is no sound, sound skips, or sound cracks.

- A connection has not been made correctly.
 - Check the connection between this unit and the connected equipment and set the input selector of the equipment to the source corresponding to this unit.
 - Installation is not correct.
 - Install the unit at an angle of less than 30° in a sturdy part of the car.

 - The unit is in pause/reverse/fast-forward mode.
 - The settings for the outputs are not made correctly.
 - The volume is too low.
 - The ATT function is activated.
 - The format is not supported.
 - Check if the format is supported by this unit.
-

Related Topic

- [Supported Formats for USB Playback](#)

In-Car Receiver
XAV-AX5600/XAV-AX5650

Sound is noisy.

- Keep cords and cables away from each other.

In-Car Receiver
XAV-AX5600/XAV-AX5650

Items cannot be played.

- Reconnect the USB device.
 - The USB port to which the USB device is connected is not appropriate.
 - Connect the USB device to the appropriate USB port that supports the file formats.
-
-

Related Topic

- [Supported Formats for USB Playback](#)

In-Car Receiver
XAV-AX5600/XAV-AX5650

The USB device takes longer to play.

- The USB device contains large-sized files or files with a complicated tree structure.

In-Car Receiver
XAV-AX5600/XAV-AX5650

Audio files cannot be played.

- USB devices formatted with file systems other than FAT12, FAT16, FAT32 or exFAT*¹ are unsupported.*²
- The USB port to which the USB device is connected is not appropriate.
 - Connect the USB device to the appropriate USB port that supports the file systems.

*¹ USB devices formatted with the exFAT file system are available only when connected to the USB port 1.

*² This unit supports FAT12, FAT16, FAT32 and exFAT, but some USB device may not support all of these. For details, refer to the operating instructions of each USB device or contact the manufacturer.

Related Topic

- [USB Port 1 and USB Port 2](#)

In-Car Receiver
XAV-AX5600/XAV-AX5650

Operations cannot be performed.

- The USB mode of the device is not set to the appropriate mode.
 - Make sure that the USB mode of the device is set to MSC or MTP mode.
 - The USB port to which the USB device is connected is not appropriate.
 - Connect the USB device to the appropriate USB port that supports the features.
-

Related Topic

- [USB Port 1 and USB Port 2](#)

In-Car Receiver
XAV-AX5600/XAV-AX5650

The connected HDMI device cannot be played.

- Check the supported file formats for the connected HDMI device.
 - HDMI devices formatted with file systems other than 480p, 576p, or 720p are unsupported.
- If [No Video Signal] appears on the display, set the resolution of the HDMI device to match the resolution of the unit.
- Check that the HDMI cable is firmly inserted to the unit. It is also recommended to use a certified HDMI cable.

In-Car Receiver
XAV-AX5600/XAV-AX5650

The other BLUETOOTH device cannot detect this unit.

- Set [Bluetooth Connection] to [ON].
 - While connecting to a BLUETOOTH device, this unit cannot be detected by another device. Terminate the current connection and search for this unit from the other device.
 - Depending on your smartphone or mobile phone, you may need to delete this unit from the history of the connected smartphone or mobile phone, then pair them again.
-

Related Topic

- [Preparing a Bluetooth® Device](#)
- [BLUETOOTH Settings \(Bluetooth\)](#)

In-Car Receiver
XAV-AX5600/XAV-AX5650

Connection is not possible.

- Check the pairing and connection procedures in the manual of the other device, etc., and perform the operation again.

In-Car Receiver
XAV-AX5600/XAV-AX5650

The name of the detected device does not appear.

- Depending on the status of the other device, it may not be possible to obtain the name.

In-Car Receiver
XAV-AX5600/XAV-AX5650

There is no ringtone.

- Raise the volume while receiving a call.
 - The speakers are not connected to the unit.
 - Connect the speakers to the unit. To select the speakers for ringtone, press HOME, then touch [Settings] and select [Phone Call Sound] in [Sound].
-
-

Related Topic

- [Sound Settings \(Sound\)](#)

In-Car Receiver
XAV-AX5600/XAV-AX5650

The talker's voice volume is low.

- Raise the volume during a call.

In-Car Receiver
XAV-AX5600/XAV-AX5650

The other party says that the volume is too low or high.

- Adjust the [MIC Gain] level.
-

Related Topic

- [Available Operations during a Call](#)

In-Car Receiver
XAV-AX5600/XAV-AX5650

Echo or noise occurs during call conversations.

- Reduce the volume.
 - Set [Speech Quality] to [Mode 1] or [Mode 2].
 - If ambient noise other than the phone call sound is loud, try reducing this noise.
 - Shut the window if road noise is loud.
 - Lower the air conditioner if the air conditioner is loud.
-

Related Topic

- [Available Operations during a Call](#)

In-Car Receiver
XAV-AX5600/XAV-AX5650

The phone sound quality is poor.

- Phone sound quality depends on reception conditions of the mobile phone.
 - Move your car to a place where you can enhance the mobile phone's signal if the reception is poor.

In-Car Receiver
XAV-AX5600/XAV-AX5650

The volume of the connected BLUETOOTH device is low or high.

- Volume level will differ depending on the BLUETOOTH device.
 - Reduce the volume level differences between this unit and the BLUETOOTH device.
-
-

Related Topic

- [Playing a BLUETOOTH Device](#)

In-Car Receiver
XAV-AX5600/XAV-AX5650

The sound skips during audio streaming or the BLUETOOTH connection fails.

- Reduce the distance between the unit and the BLUETOOTH device.
- If the BLUETOOTH device is stored in a case which interrupts the signal, remove the case while using the device.
- Several BLUETOOTH devices or other devices (e.g. ham radio devices) which emit radio waves are used nearby.
 - Turn off the other devices.
 - Increase the distance between the unit and other devices.
- Playback sound stops momentarily when this unit is connecting to a mobile phone. This is not a malfunction.

In-Car Receiver
XAV-AX5600/XAV-AX5650

The connected BLUETOOTH device cannot be controlled during audio streaming.

- Check that the connected BLUETOOTH device supports AVRCP.

In-Car Receiver
XAV-AX5600/XAV-AX5650

Some functions do not work.

- Check that the connecting device supports the functions in question.

In-Car Receiver
XAV-AX5600/XAV-AX5650

A call is answered unintentionally.

- The connecting phone is set to start a call automatically.
 - [Auto Answer] of this unit is set to [ON].
-
-

Related Topic

- [Available Operations during a Call](#)

In-Car Receiver
XAV-AX5600/XAV-AX5650

Pairing failed due to time out.

- Depending on the connecting device, the time limit for pairing may be short. Try completing the pairing within the time.

In-Car Receiver
XAV-AX5600/XAV-AX5650

Cannot pair.

- The unit may not be able to pair with a previously paired BLUETOOTH device after initializing the unit if the pairing information of the unit is on the BLUETOOTH device. In this case, delete the pairing information of the unit from the BLUETOOTH device, and then pair them again.

In-Car Receiver
XAV-AX5600/XAV-AX5650

The BLUETOOTH function cannot be operated.

- Turn the ignition off. Wait for a while, then turn the ignition to the ACC position.

In-Car Receiver
XAV-AX5600/XAV-AX5650

No sound is output from the car speakers during a handsfree call.

- If the sound is output from the mobile phone, set the mobile phone to output the sound from the car speakers.

In-Car Receiver
XAV-AX5600/XAV-AX5650

A mature channel is not blocked although parental control setting has been made.

- If you tune to a mature channel, the passcode display will appear. Once you have entered the passcode, you will have unblocked parental control for all channels until the unit is powered down or you turn parental control back on. Set [Parental Control] to [Locked] in the SXM option (●●●) again.
-

Related Topic

- [Using SXM Option Functions](#)

In-Car Receiver
XAV-AX5600/XAV-AX5650

The Apple CarPlay icon does not appear on the HOME screen.

- Your iPhone is not compatible with Apple CarPlay.
 - Refer to the manual supplied with your iPhone, or visit the Apple CarPlay website.

- Disconnect your iPhone from the USB port 1 and reconnect it again.
- The USB port to which your iPhone is connected is not appropriate.
 - Connect your iPhone to the USB port 1.

- Apple CarPlay may not be available in your country or region.
- Make sure a certified Lightning cable is used to connect your iPhone and the unit.

In-Car Receiver
XAV-AX5600/XAV-AX5650

The Android Auto icon does not appear on the HOME screen.

- Check your Android phone and accept the disclaimers and permission requests required to use Android Auto on your Android phone.
- There is no Android Auto application installed on your Android phone.
 - Download and install the Android Auto application onto your Android phone.
- Your Android phone is not compatible with Android Auto.
 - Your Android phone needs to support Android Auto. Refer to the manual supplied with your Android phone, or visit the Android Auto website.
- Disconnect your Android phone from the USB port 1 and reconnect it again.
- The USB port to which your Android phone is connected is not appropriate.
 - Connect your Android phone to the USB port 1.
- Android Auto may not be available in your country or region.

In-Car Receiver
XAV-AX5600/XAV-AX5650

WebLink™ cannot be used.

- Installing the “WebLink Host” app to your iPhone/Android phone is required.
 - Check the following site and install the “WebLink Host” app.
<http://abaltatech.com/WL>
 - Check your iPhone/Android phone and accept the disclaimers and permission to use WebLink™ on your iPhone/Android phone.

- Disconnect your iPhone/Android phone from the USB port 1 and reconnect it again.
- The USB port to which your iPhone/Android phone is connected is not appropriate.
 - Connect your iPhone/Android phone to the USB port 1.

- Restart your iPhone/Android phone.
- WebLink™ may not be available in your country or region.

In-Car Receiver
XAV-AX5600/XAV-AX5650

There is no sound. / The sound is low.

- Your iPhone/Android phone is not connected to the unit via BLUETOOTH.
 - Make a BLUETOOTH connection.

- The volume level of [Bluetooth] is low.
 - Adjust the volume level of [Bluetooth].

In-Car Receiver
XAV-AX5600/XAV-AX5650

General

Cannot play this content.

For USB source:

- The currently selected content cannot be played back, or skipped to the next one.
 - The content is not in a supported file format. Check supported file formats.

For HDMI source:

- The unit receives unsupported input signal.
- There may be malfunction of connection cable.
 - Replace the cable.

Device no response

- The unit does not recognize the connected USB device.
 - Reconnect the USB device.
 - Check that the USB device is supported by the unit.

No Playable Data

- The USB device has no playable data.
 - Load music data/files into the USB device.

Overcurrent caution on USB.

- The USB device is overloaded.
 - Disconnect the USB device.
 - The USB device has a fault, or an unsupported device is connected.

USB device not supported

- For details on the compatibility of your USB device, visit the support site.

USB hub not supported

- USB hubs are not supported on this unit.

Related Topic

- [Sound Settings \(Sound\)](#)
- [Supported Formats for USB Playback](#)

In-Car Receiver
XAV-AX5600/XAV-AX5650

BLUETOOTH

Bluetooth device is not found.

- The unit cannot detect a connectable BLUETOOTH device.
 - Check the BLUETOOTH setting of the connecting device.
- No device is in the list of registered BLUETOOTH devices.
 - Perform pairing with a BLUETOOTH device.

Handsfree device is not available.

- A mobile phone is not connected.
 - Connect a mobile phone.
-

Related Topic

- [Pairing and Connecting with a BLUETOOTH Device](#)
- [Connecting with a Paired BLUETOOTH Device](#)

In-Car Receiver
XAV-AX5600/XAV-AX5650

SiriusXM Connect Vehicle Tuner (XAV-AX5600(UC))

Channel Locked Please Enter the Lock Code

- The channel that you have requested is Locked by the radio Parental Control feature. See “[Setting a Parental Control](#)” for more information on the Parental Control feature and how to access locked channels.

Channel Not Available

- The channel that you have requested is not a valid SiriusXM channel or the channel that you were listening to is no longer available.
- You may also see this message briefly when first connecting a new SiriusXM Connect Vehicle Tuner. Visit www.siriusxm.com in the USA or www.siriusxm.ca in Canada for SiriusXM channel lineup information.

Channel Not Subscribed Call SiriusXM to Subscribe

- The channel that you have requested is not included in your SiriusXM subscription package or the channel that you were listening to is no longer included in your SiriusXM subscription package. If you have questions about your subscription package or would like to subscribe to this channel, please contact SiriusXM.

In the USA, you can activate online or by calling SiriusXM Listener Care:

- Visit www.siriusxm.com/activatenow
- Call SiriusXM Listener Care at 1-866-635-2349

For Canadian Subscriptions, please contact:

- Visit www.siriusxm.ca/activate
- Call SiriusXM Customer Care at 1-888-539-7474

Check Antenna

- The radio has detected a fault with the SiriusXM antenna (aerial).
- The antenna (aerial) cable may be either disconnected or damaged.
 - Verify that the antenna (aerial) cable is connected to the SiriusXM Connect Vehicle Tuner.
 - Inspect the antenna (aerial) cable for damage and kinks.
 - Replace the antenna (aerial) if the cable is damaged. SiriusXM products are available at your local car audio retailer or online at <https://shop.siriusxm.com/all-parts/>

Check Tuner

- The radio is having difficulty communicating with the SiriusXM Connect Vehicle Tuner.
- The tuner may be disconnected or damaged.
 - Verify that the SiriusXM Connect Vehicle Tuner cable is securely connected to the radio.

Incorrect Pass Code entered

- Passcode input failed.
 - Check that the passcode has been entered correctly.
 - If you forget your passcode, perform [SXM Reset] in [General]. Note that performing [SXM Reset] will initialize all the SiriusXM settings and stored contents in the SiriusXM Connect Vehicle Tuner.

No Signal

- SiriusXM Connect Vehicle Tuner is having difficulty receiving the SiriusXM satellite signal.
 - Verify that your vehicle is outdoors with a clear view of the sky.

- Verify that the SiriusXM magnetic mount antenna (aerial) is mounted on a metal surface on the outside of the vehicle.
- Move the SiriusXM antenna (aerial) away from any obstructions.
- Inspect the antenna (aerial) cable for damage and kinks.
- Consult the SiriusXM Connect Vehicle Tuner installation manual for more information on antenna (aerial) installation.
- Replace the antenna (aerial) if the cable is damaged. SiriusXM products are available at your local car audio retailer or online at <https://shop.siriusxm.com/all-parts/>

Subscription Updated Press Enter to Continue

- The radio has detected a change in your SiriusXM subscription status.
 - Press Enter to clear the message.
If you have questions about your subscription, please contact SiriusXM.
In the USA, you can activate online or by calling SiriusXM Listener Care:
Visit www.siriusxm.com/activatenow
Call SiriusXM Listener Care at 1-866-635-2349
For Canadian Subscriptions, please contact:
Visit www.siriusxm.ca/activate
Call SiriusXM Customer Care at 1-888-539-7474

Related Topic

- [Setting a Parental Control](#)
- [General Settings \(General\)](#)

In-Car Receiver
XAV-AX5600/XAV-AX5650

WebLink™

Please install and start the WebLink Host app on your phone. For more information visit www.abaltatech.com/wl

- Visit www.abaltatech.com/wl, and check the detail.
-

Related Topic

- [WebLink™](#)

In-Car Receiver
XAV-AX5600/XAV-AX5650

DAB radio (XAV-AX5650(EUR))

No Station

- The DAB signal cannot be received.
 - Perform an auto tune.
 - Check the connection of the DAB antenna (aerial) (not supplied).
 - Check that [Antenna Power] is set to [ON].

Receiving

- The unit is waiting to receive a DAB station.
-

Related Topic

- [Listening to the DAB/DAB+ Radio](#)
- [Using DAB Option Functions](#)

In-Car Receiver
XAV-AX5600/XAV-AX5650

Customer Support Websites

You can access the following customer support websites to get support information about your system.

For customers in the USA/Canada/Latin America:

<https://www.sony.com/am/support>

For customers in European countries:

<https://www.sony.eu/support>

For customers in other countries/regions:

<https://www.sony-asia.com/support>

For customers in the USA

If you have any questions/problems regarding this product, try the following:

1. Read Troubleshooting in this Help Guide.
2. Please contact (U.S.A. only);
Call 1-800-222-7669
URL <https://www.SONY.com>

For customers in European countries

Register your product online now at:

<https://www.sony.eu/mysony>

In-Car Receiver
XAV-AX5600/XAV-AX5650

About the “Support by Sony” App

When you install the “Support by Sony” app on your smartphone, you can get software update information conveniently.

“Support by Sony” app - Find information and get notifications about your product:



- ✓ News & Alerts
- ✓ Software updates
- ✓ Tutorials
- ✓ Tips & Tricks

<https://sony.net/SBS>

Visit the “Support by Sony” website at sony.net/SBS, and bookmark the model name of the unit, “XAV-AX5600” or “XAV-AX5650”, when you visit the website.